

WARRANTY

Dear Customer,

You are now the privileged owner of Transducer a product that ranks the first of its kind in the world.

Company provides 12 months warranty from the original date of purchase against defective material and workmanship.

In the unlikely event of failure of this Transducer within the warranty period, Company will repair the Transducer free of charge. Please hand over the Transducer to the dealer / Stockiest from whom you have purchased along with this card and relevant cash memo / Invoice. This warranty entitles you to bring the Transducer at your cost to the nearest stockiest / dealer and collect it after repairs.

NO TRANSPORTATION CHARGES WILL BE REIMBURSED

The warranty is not valid in following cases:

- 1) Warranty card duly signed / stamped and original cash memo / invoice are not sent along with the Transducer .
- 2) Complete warranty card is not presented to authorised person at the time of repairs.
- 3) Transducer not used as per the instruction in the user manual.
- 4) Defect caused by misuse, negligence, accidents, tampering and acts of god.
- 5) Improper repairing by any person not authorised by the company.
- 6) Any sort of modification, alteration is made in electrical circuitry.
- 7) Seal provided inside is broken.

In case of dispute to the validity of warranty, the decision of Company's service center will be final.

If you bought this Transducer directly from the company, and if you notice transit Damage, then you must obtain the insurance surveyors report and forward it to Company.

Thank you.

(To be filled by authorized dealer)

Model No. : _____

Serial Number : _____

Date of Purchase : _____

Cash Memo / Invoice No. : _____

Dealer's Signature : _____

Dealer's Stamp : _____

Scope of Supply:

- 1) Transducer
- 2) Instruction manual
- 3) Test Certificate
- 4) Warranty Card
- 5) RS-232 Interface Cable*
- 6) Software*

* Only with MXX Transducer

Operating Instructions Universal Transmitter *RishDucer* V 604-II



30980/01.22(Rev.H)

RISHABH INSTRUMENTS PVT. LTD.

F-31, MIDC, Satpur, Nasik - 422 007, India.

Tel : +91 253 2202 162, 2202 165

E-mail : service@rishabh-instruments.com

www.rishabh-instruments.com



Operating Instructions Universal Transmitter RishDucer V 604-II

Contents

1. Read first and then	2
2. Scope of supply	2
3. Overview of the parts	2
4. Brief description	3
5. Technical data	3
6. Exchanging frontplates	6
7. Withdrawing and inserting the device	6
8. Mounting	6
9. Electrical connections	7
10. Programming the transmitter	9
11. Commissioning	10
12. Maintenance	10
13. Releasing the transmitter	10
14. Dimensional drawings	10

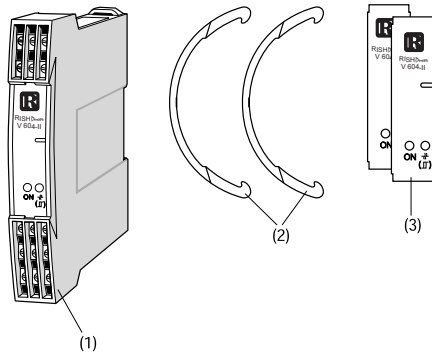

1. Read first and then ...



The proper and safe operation of the device assumes that the Operating Instructions are **read** and the safety warnings given in the various Sections

8. Mounting

9. Electrical connections

10. Programming the transmitter

11. Commissioning

are **observed**.

The device should only be handled by appropriately trained personnel who are familiar with it and authorised to work in electrical installations.

The instrument must only be opened for the setting of the DIP switch, as described in section "10. Programming the transmitter."

The guarantee is no longer valid if the instrument is further tampered with.

2. Scope of supply

Transmitter (1)

Order Code : Significance of the 2nd. and 3rd. digits
604-II - 1 xx

- 1 Standard, measuring input not I.S., power supply 24... 60 V DC/AC
- 2 Standard, measuring input not I.S., power supply 85...230 V DC/AC

2 Standard climatic rating:
instrument with cold junction compensation

2 **withdrawing handles(2)** (for withdrawing the device from its housing)

2 **Frontplates (3)** (for notes)

1 Software CD (configuration software for Rish Ducer V 604-II)

3. Overview of the parts

Figure 2 shows those parts of the transmitter of consequence for mounting, electrical connections, programming connections and other operations described in the Operating Instructions.

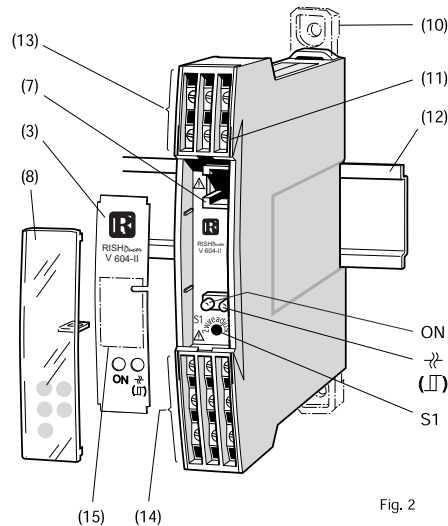



Fig. 2

Notes

For the setting of the DIP switch, the main PCB must be withdrawn from the transmitter housing (see Section "7. Withdrawing and inserting the device") and setting the DIP switches as shown in Table 7. **The eight DIP switches are located at the outer right on the conventional component side of the PCB.**

Table 7

DIP switches	Type of output signal
	load-independent current
	load-independent voltage

11. Commissioning

Switch on the measuring input and the power supply. The green LED flashes for 5 seconds after switching on and then lights continuously.

 The power supply unit must be capable of supplying a brief current surge when switching on. The transmitter presents a low impedance at the instant of switching which requires a current I_{start} of ...

... $I_{start} \geq 160 \text{ mA}$ for the version with a power supply range of 24 – 60 V DC/AC

or

... $I_{start} \geq 35 \text{ mA}$ for the version with a power supply range of 85 – 230 V DC/AC

12. Maintenance

No maintenance is required.

13. Releasing the transmitter

Release the transmitter from a top-hat rail as shown in Fig. 10.

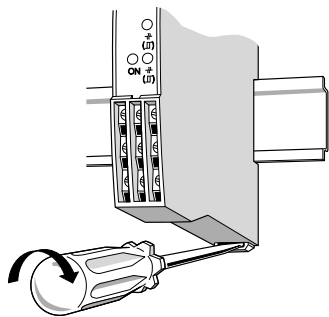

Fig. 10

14. Dimensional drawings

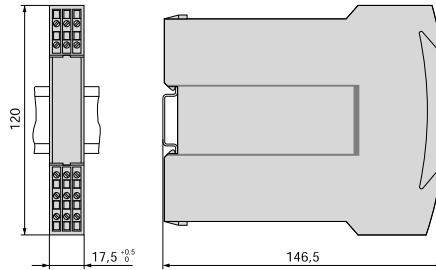

Fig. 11. RishDucer V 604-II clipped onto a top-hat rail (35 x 15 mm or 35 x 7.5 mm) acc. to EN 50 022.

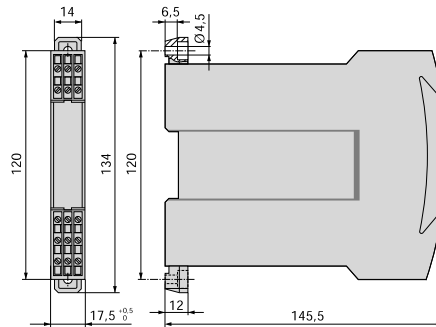



Fig. 12. RishDucer V 604-II with the screw hole brackets pulled out for wall mounting.

- (3) Front label
- (7) Programming connector
- (8) Transparent cover
- (10) Fixing bracket
- (11) Opening for withdrawing clip (for opening the housing)
- (12) Top-hat rail 35 x 15 mm or 35 x 7.5 mm (EN 50 022)
- (13) Terminals 1, 2, 6, 7, 11, 12 measuring input M
- (14) Terminals 4, 9 measuring output A1
3, 8 measuring output A2
5, 10 power supply H
13, 14, 15 output contact K
- (15) Space for notes
- S1 Calibration button for automatically compensating the leads of two-wire resistance thermometer circuits
- ON Green LED for signalling operating statuses
-  Red LED for open-circuit sensor supervision or
-  as relay status signal (open-circuit sensor supervision not in operation)

4. Brief description

Resistance thermometers, thermo-couples, resistance sensors, potentiometers or DC current or voltage sources are connected to the programmable universal transmitter RishDucer V 604-II which then converts the corresponding input signals into impressed current or voltage output signals.

Measured variables and measuring ranges are programmed with the aid of a PC, a programming cable and the programming software. Specific measured variable data such as output signal, transmission characteristics, active direction and open-circuit sensor supervision data can also be programmed.

Transmitters supplied ex stock are configured as follows:

- Measuring input	0...5 V DC
- Measuring output	0...20 mA linear Fixed value 0% during 5 s after switching on
- Settling time	0.7 s
- Break monitoring	Inactive
- Mains ripple suppression	50 Hz
- Limit function	Inactive

5. Technical data

Measuring input

Measured variable M

The measured variable M and the measuring range can be programmed

Table 1: Measured variables and measuring ranges

Measured variables	Measuring ranges		
	Limits	Min. span	Max. span
DC voltages			
direct input	$\pm 300 \text{ mV}^1$	6 mV	300 mV
via voltage divider	$\pm 40 \text{ V}^1$	800 mV	40 V
DC currents			
low current range	$\pm 12 \text{ mA}^1$	0.19 mA	12 mA
high current range	- 50 to + 100 mA ¹	13 mA	100 mA
Temperature monitored by two, three or four-wire resistance thermometers	- 200 to 850 °C		
low resistance range	0...740 Ω^1	15 Ω	740 Ω
high resistance range	0...5000 Ω^1	100 Ω	5000 Ω
Temperature monitored by thermo-couples	- 270 to 1820 °C	6 mV	300 mV
Variation of resistance of remote sensors/potentiometers			
low resistance range	0...740 Ω^1	15 Ω	740 Ω
high resistance range	0...5000 Ω^1	100 Ω	5000 Ω

¹Note permissible value of the ratio "full-scale value/span ≤ 20 ".

Measuring output

Output signals A1 and A2

The output signals can be either load-independent DC currents I_A or DC voltages U_A . The desired mode is set on DIP switches and the setting range is programmed on a PC. A1 and A2 are not DC isolated and the same value is available at both outputs. Since the output A1 & A2 are not isolated, in order to observe the output at A2 ensure the presence of connection shorting of output A1 (Applicable for Current output only).

Standard ranges for I_A : 0...20 mA or 4...20 mA

External resistance I_{A1} : $R_{ext} \text{ max. [k}\Omega] = \frac{15 \text{ V}}{I_{AN} \text{ [mA]}}$

resp. $= \frac{-12 \text{ V}}{I_{AN} \text{ [mA]}}$

I_{AN} = Full-scale output current value

External resistance I_{A2} : $R_{ext} \text{ max. [k}\Omega] = \frac{0.3 \text{ V}}{I_{AN} \text{ [mA]}}$

Standard ranges for U_A : 0...5, 1...5, 0...10 or 2...10 V

Load capacity U_{A1} / U_{A2} : $R_{ext} \text{ [k}\Omega] \geq \frac{U_A \text{ [V]}}{20 \text{ mA}}$

Power supply H

AC/DC power pack (DC and 45...400 Hz)

Table 2: Rated voltages and tolerances

Rated voltage U_N	Fuse	Tolerances	Instrument version
24... 60 V DC / AC	T 160 mA	DC - 15...+ 33% AC \pm 15%	Standard
85...230 V ¹ DC / AC	T 100 mA		

Power consumption: < 1.4 W resp. < 2.7 VA

Output contact K

The output contact can be used:

- as an additional means of signalling operation of the open-circuit sensor supervision when the transmitter is used in conjunction with resistance thermometers, thermo-couples, resistance sensors and potentiometers.
- to monitor the measured variable in relation to a limit where an additional means of signalling operation of the open-circuit sensor supervision (see "a") is considered unnecessary.
- to monitor the measured variable in relation to a limit when measuring a DC voltage or a current.

Note on a): The relay has to be activated by programming its operating mode as "energised" or "de-energised".
Available operating modes are:
"Output at last value, relay energised"
"Output at last value, relay de-energised"
"Output at setting, relay energised"
"Output at setting, relay de-energised"
Relay pick-up/reset threshold:
1 to 15 k Ω , acc. to measuring mode and range

Note on b): The relay must be activated by programming:
"Output corr. to input variable, relay inactive"
The limit must also be programmed (see Section "Limit")

Note on c): It is only necessary to program the limit (see remarks on "b)" above)

Limit value

Limit value type: Programmable
- for monitoring the input variable in relation to a lower or upper limit between -10 and 110%² (see left side of Fig. 3)

Hysteresis: Programmable from 0.5 to 100%² or 1 to 100%²/s

Operating and resetting delays: Programmable from 1 to 60 s

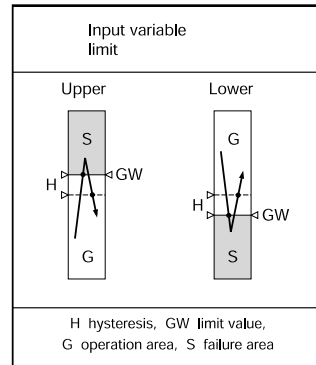

Fig. 3

Light emitting diodes

Table 3: Red LED (\rightarrow , \leftarrow), Fig. 2)

Operating modes	Red LED
Open-circuit sensor or lead	lit
Above or below limit ³	not lit (acc. to programming)

¹ Caution! Observe note in Section 9.3

² In relation to analogue output spans A1 and A2

³ Only applies when the output contact K is used for monitoring the input variable in relation to a limit.

Table 4: Green LED (ON, Fig. 2)

Operating status	Green LED
Switching on	Flashes at 1 Hz for 5 seconds after switching on power supply
Normal operation	Continuously ON
Out of range	Flashes at 1 Hz
Automatic lead compensating using calibration button (S1, Fig. 2)	Flashes at 2 Hz
Open-circuit sensor	Flashes at 1 Hz
Power supply failure	Extinguished

Notes

9.1.1 Connection to thermo-couples (connection diagram No. 8)

With instruments programmed for thermocouple connection with internal cold junction compensation, compensating leads must be used from the thermocouple to the RishDucer V 604-II.

No line balancing is required.

9.1.2 Connection to resistance thermometers or potentiometer

9.1.2.1 Two-wire connection (connection diagram No. 4)

Terminals **1** and **6** must be connected in the case of a two-wire measurement. The influence of the lead resistance is compensated automatically by a lead resistance measuring circuit. This is done by shorting the sensor and pressing the **calibration button S1** (located behind the front cover, see Fig. 2) for at least 3 seconds. Wait until the green LED (stand-by signal) no longer flashes. Remove the short-circuit from across the sensor.

9.1.2.2 Three-wire connection (connection diagram No. 5)

It is assumed that the three leads of a three-wire connection have identical resistances and no compensation is necessary. The lead resistance must not be greater than 30 Ω per lead.

9.1.2.3 Four-wire connection (connection diagram No. 6)

The four-wire measurement is independent of lead resistance within wide limits and therefore no compensation is necessary. The lead resistance must not be greater than 30 Ω per lead.

9.2 Measuring output leads

Connect the output leads for output A1 to terminals 4 (-) and 9 (+) and for output A2 (field indicator) to terminals 3 (-) and 8 (+) as shown in Fig. 9.

Note: The maximum permissible external resistance $R_{ext,max}$ of the transmitter must not be exceeded (see Section "5. Technical data").

9.3 Connecting the power supply

Connect the power supply to terminals 5 (=) and 10 (\pm) as shown in Fig. 9.

A two-pole switch must be included in the supply connection where facility for switching RishDucer V 604-II off is desired.

Note: An external supply fuse with a rupture capacity \leq 20 A must be provided for DC supply voltages < 125 V.

9.4 Connecting the output contact

Connect the output contact signalling leads to terminals 13, 14 and 15 (see Fig. 9 and Table 6).

Table 6

Contact output K	Material	Contact rating
	Gold flashed silver alloy	AC: \leq 2 A/250 V (500 VA) DC: \leq 1 A, 0.1...250 V (30 W)

Terminals 13 and 14 are connected in the event of a power supply failure.

10. Programming the transmitter

A PC with Windows 98 / XP operating system, the programming cable PRKAB 600 and the programming software (configuration software for Rish Ducer V 604-II) are needed to program the transmitter.



1. It is not permitted to use the programming cable PRKAB 600 for programming devices of other manufacture.

The programming connector (7) is not electrically insulated from the intrinsically safe measuring input circuit. It is therefore essential to observe the following :

Programming may only be performed using the programming cable PRKAB 600

- The Voltage applied to the FCC connector must not exceed 253 v. For this reason, no device may be connected to the input circuit of the V 604-II that have a supply >253V. Pay special attention to this when measuring DC voltage with NLB686 numbers. Note that in this case the component certificate is void. We also recommend that for safety, the Ex symbol should be crossed out to make it invalid.
- The programming connector (7) max only be used briefly.
- The plug connector between the socket connector and the expandable cable (see arrow on the diagram) **must not be withdrawn** when the expandable cable is connected to the programming instrument. For this reason, the expandable cable must be plugged into the socket connector before establishing the connection between the device and the PC.

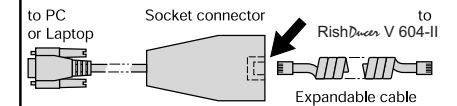

Of the programmable details listed in section «4. Brief description», **one** parameter – the **output signal** – has to be determined by PC programming as well as mechanical setting on the **transmitter**:

... the output signal **range** by PC

... the **type** of output has to be set by DIP switch on the instrument.

9.1 Alternative measurement connections



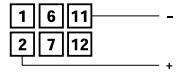
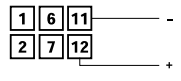
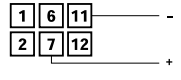
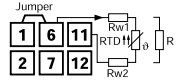
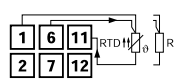
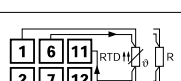
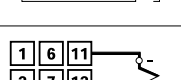
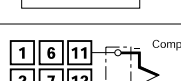
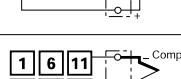
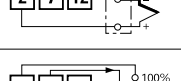
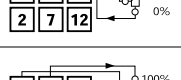

Connect the measuring leads to suit the application as given in Table 5.

Table 5: Measuring input

Measuring mode / application	Measuring range limits	Measuring span	No	Connecting diagram Terminal arrangement
DC voltage (direct input)	- 300...0...300 mV	6...300mV	1	
DC voltage (input via voltage divider)	- 40...0...40 V	0.8 ... 40 V	2	
DC current	- 12...0... 12 mA/ - 50...0...100 mA	0.19 ... 12 mA/ 13 ... 100 mA	3	
Resistance thermometer RTD or resistance measurement R, two-wire connection $R_{w1} + R_{w2} \leq 60 \Omega$	0... 740 Ω / 0...5000 Ω	15 Ω ... 740 Ω / 100 Ω ... 5000 Ω	4	
Resistance thermometer RTD or resistance measurement R, three-wire connection $R_{Ltg.} \leq 30 \Omega$ per wire	0... 740 Ω / 0...5000 Ω	15 Ω ... 740 Ω / 100 Ω ... 5000 Ω	5	
Resistance thermometer RTD or resistance measurement R, four-wire connection $R_{Ltg.} \leq 30 \Omega$ per wire	0... 740 Ω / 0...5000 Ω	15 Ω ... 740 Ω / 100 Ω ... 5000 Ω	6	
Thermo-couple TC Cold junction compensation internal	- 300...0...300 mV	6...300mV	7	
Thermo-couple TC Cold junction compensation external	- 300...0...300 mV	6...300mV	8	
Thermo-couple TC in a summation circuit for deriving the mean temperature	- 300...0...300 mV	6...300mV	9	
Resistance transmitter WF $R_{Ltg.} \leq 30 \Omega$ per wire	0... 740 Ω / 0...5000 Ω	15 Ω ... 740 Ω / 100 Ω ... 5000 Ω	10	
Resistance transmitter WF DIN $R_{Ltg.} \leq 30 \Omega$ per wire	0... 740 Ω / 0...5000 Ω	15 Ω ... 740 Ω / 100 Ω ... 5000 Ω	11	

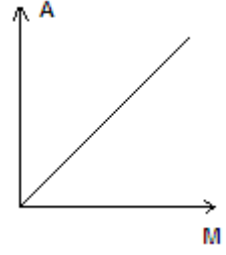
Output Characteristic :

Input =M Output =A

Measured Variable	Characteristics	
DC Voltage		Linearized Characteristic
DC Current		
RTD(Linear variation of output=A with resistance of RTD. M= resistance)		
Thermocouple (Linear variation of output=A with voltage(mV) of thermocouple. M=mV)		Linearized Characteristic
Potentiometer		
DC Voltage		Function
DC Current		
RTD(Linear variation of output=A with temperature. M= Deg C), Note: In this case, variation of Output=Awith resistance of RTD is non-linear.		Non Linearized Characteristic
Thermo couple(linear variation of output=A with Temperature. M=Deg C) Note: In this case, variation of output=A with mV of Thermocouple is Non-linear.		
Potentiometer		

Accuracy

Basic accuracy: Limit of error $\leq \pm 0.2\%$
 Additional error: $< \pm 0.3\%$ for linearised characteristic

$< \pm 0.3\%$ for a high ratio between full scale value and measuring range $>$ factor 10, e.g. Pt100 174.84ohm...194.07ohm approx. 200°C ...250°C

$< \pm 0.3\%$ for current output $<$ 10mA span
 $< \pm 0.1\%$ for bipolar outputs
 $< \pm 0.3\%$ for voltage output $<$ 8V Span

$< 2^*$ (basic and additional error)
 For two-wire resistance Measurement

$< \pm 0.1\%$ for the ranges other than standard ranges

Ambient conditions

Commissioning temp.: -10 to $+55$ °C

Operating temperature: -25 to $+55$ °C,

Storage temperature: -40 to $+70$ °C

Relative humidity of annual mean:
 $\leq 75\%$ for standard climatic rating
 $\leq 95\%$ for enhanced climatic rating

Altitude : 2000 m max.

Indoor use statement

Programming connector on the transmitter

Interface: RS 232 C

FCC-68 socket: 6/6 pin

Signal level: 0/3 V

Power consumption: Approx. 50 mW

6. Exchanging frontplates

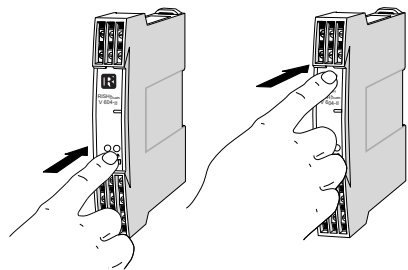

Fig. 4. Left: Removing the transparent cover
 Right: Inserting the transparent cover.

Apply gentle pressure to the transparent cover as shown in Fig. 4 until pops out on the opposite side. The label in the cover can be replaced and used for notes. After replacing the label in the transparent cover, the trans-

parent cover can be snapped into the front of the device again. This is done by inserting it behind the edge at the bottom and pressing it gently down and to the rear with the finger until it snaps into place (right side of Fig. 4).

7. Withdrawing and inserting the device

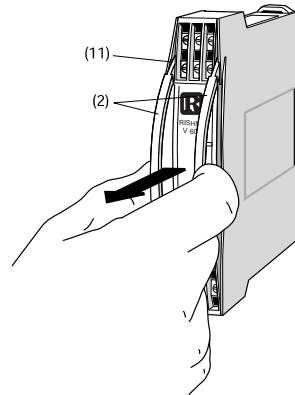

Fig. 5

Insert the Pull-out clamps S17 (2) into the openings (11) until they snap into place. Withdraw the front part together with the main PCB out of the housing.

To reassemble the unit, insert the front part together with the main PCB into the housing until the swallow-tailed sections engage in each other.

8 Mounting

The RishDucer V 604-II can be mounted either on a top-hat rail or directly onto a wall or mounting plate.



When deciding where to install the transmitter (measuring location), take care that the **limits** of the operating temperature **are kept**:
 -25 and $+55$ °C for standard instruments

8.1 Top-hat rail mounting

Simply clip the device onto the top-hat rail (EN 50 022) (see Fig. 6).

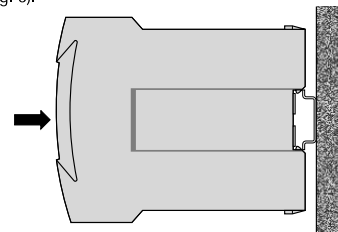

Fig. 6. Mounting on top-hat rails 35×15 or 35×7.5 mm.

8.2 Wall mounting

Drill 2 holes of approx. 4.5 mm diameter in the wall or panel as shown in the drilling pattern (Fig. 7).

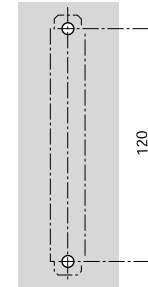

Fig. 7. Drilling pattern.

While pressing the latch (18) in the base of the device (Fig. 8, left), pull out the transmitter securing brackets (10).

Now secure the transmitter to the wall or panel using two 4 mm diameter screws.

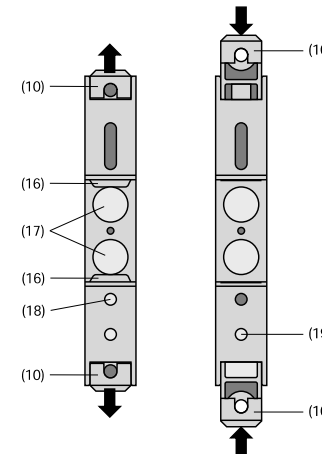

Fig. 8. Rear of device.

(10) Screw hole brackets
 (16) Top-hat rail clip
 (17) Rubber buffers
 (18) Latch for pulling the screw hole brackets out
 (19) Latch for pushing the screw hole brackets in

Note:

To return the brackets to their original positions, the latch (19) in the base of the device has to be depressed before applying pressure to the securing brackets (10) (see Fig. 8, right).

9. Electrical connections

The electrical connections are made to screw terminals which are easily accessible from the front of the transmitter (see Fig. 9) and can accommodate wire gauges up to 1×2.5 mm².



Make sure that the cables are not live when making the connections!

The 230 V power supply and 250 V contact output is potentially dangerous



Also note that ...

... the data required to carry out the prescribed measurement must correspond to those marked on the nameplate of RISHDucer V 604 (→ measuring input M, → measuring outputs A1 and A2, → power supply H and → output contact K, see Fig. 9!)

... the total loop resistance connected to the output (receiver plus leads) **does not** exceed the maximum permissible value R_{ext} , see **"Measuring output"** in Section "5. Technical data" for the maximum values of R_{ext} !

... the measurement input and output cables should be twisted pairs and run as far as possible away from heavy current cables!

In all other respects, observe all local regulations when selecting the type of electrical cable and installing them!

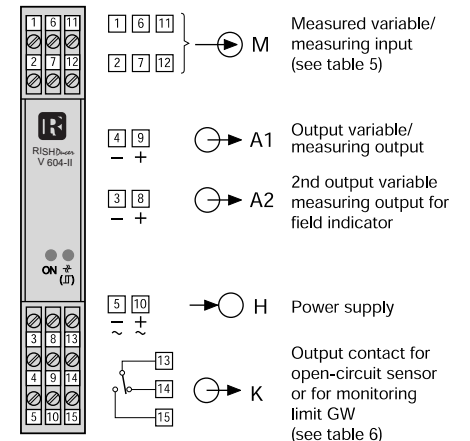

Fig. 9. Terminal allocation.