

KLEA
Energy Analyzer

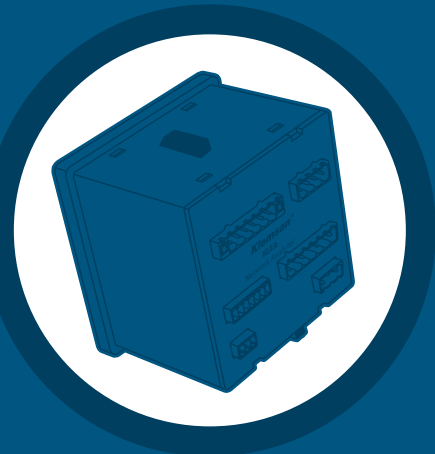

**USER
MANUAL**

TABLE OF CONTENTS

SECTION 1	GENERAL INFORMATION	10
1.1	Symbols.....	10
1.2	General Warnings	10
1.3	Receipt Control and Contents of Delivery	11
1.4	KLEA Energy Analyzer	11
1.5	KleaCom Software.....	12
1.6	KLEA Front Panel.....	13
1.7	Four-Quadrant Representantion	14
SECTION 2	INSTALLATION	16
2.1	Preparing for Installation	16
2.2	MOUNTING	16
2.3	Wiring Diagrams	19
2.3.1	Three Phase Connection With Neutral (3P4W)	19
2.3.2	Three Phase Connection No Neutral (3P3W)	20
2.3.3	Three Phase No Neutral Aron Connection	20
2.3.4	Digital Output Connection Diagram	21
2.4	Dimensions	21
SECTION 3	MENUS	23
3.1	“First Power-on” Settings.....	23
3.1.1	Dil / Language	23
3.1.2	Date	24
3.1.3	Time.....	25
3.1.4	Current Transformer Ratio (CTR)	25
3.1.5	Voltage Transformer Ratio (VTR)	27
3.1.6	Connection	27
3.1.7	Start	28
3.2	Startup Screen	28
3.2.1	Settings	29
3.2.1.1	Setup Menu	29
3.2.1.1.1	Network Menu.....	30
3.2.1.1.1.1	Current Transformer Ratio	30
3.2.1.1.1.2	Voltage Transformer Ratio.....	31
3.2.1.1.1.3	Connection	31
3.2.1.1.1.4	Demand Period	32
3.2.1.1.1.5	Power Unit	32
3.2.1.1.2	Device Menu	33
3.2.1.1.2.1	Language.....	33
3.2.1.1.2.2	Contrast.....	34
3.2.1.1.2.3	Password Protection and New Password.....	34
3.2.1.1.2.4	Display on Selection.....	35
3.2.1.1.2.5	Display on Time	35
3.2.1.1.3	Energy Menu	35
3.2.1.1.3.1	T1_1 start time.....	36
3.2.1.1.3.2	T1_2 start time.....	36

3.2.1.1.3.3	T1_3 start time	37
3.2.1.1.3.4	Start of day.....	38
3.2.1.1.3.5	Start of month	38
3.2.1.1.3.6	T1 kWh.....	38
3.2.1.1.3.7	T1 kWh E.	38
3.2.1.1.3.8	T1 kVArh I.	38
3.2.1.1.3.9	T1 kVArh E.	38
3.2.1.1.3.10	T1_1 kWh	38
3.2.1.1.3.11	T1_1 kWh E.....	38
3.2.1.1.3.12	T1_1 kVArh I.	38
3.2.1.1.3.13	T1_1 kVArh E.	38
3.2.1.1.3.14	T1_2 kWh	39
3.2.1.1.3.15	T1_2 kWh E.....	39
3.2.1.1.3.16	T1_2 kVArh I.	39
3.2.1.1.3.17	T1_2 kVArh E.	39
3.2.1.1.3.18	T1_3 kWh	39
3.2.1.1.3.19	T1_3 kWh E.....	39
3.2.1.1.3.20	T1_3 kVArh I.	39
3.2.1.1.3.21	T1_3 kVArh E.	39
3.2.1.1.3.22	T2 kWh.....	39
3.2.1.1.3.23	T2 kWh E.	39
3.2.1.1.3.24	T2 kVArh I.	39
3.2.1.1.3.25	T2 kVArh E.....	40
3.2.1.1.4	Digital Input Menu.....	40
3.2.1.1.4.1	Input1 Menu.....	41
3.2.1.1.4.1.1	Mode	41
3.2.1.1.4.1.2	Delay	42
3.2.1.1.4.2	Input 2 Menu.....	42
3.2.1.1.4.3	Input 3 Menu (optional).....	42
3.2.1.1.4.4	Input 4 Menu (optional).....	43
3.2.1.1.4.5	Input 5 Menu (optional).....	43
3.2.1.1.4.6	Input 6 Menu (optional).....	43
3.2.1.1.4.7	Input 7 Menu (optional).....	43
3.2.1.1.5	Digital Output Menu	43
3.2.1.1.5.1	Output1 Menu.....	44
3.2.1.1.5.2	Output2 Menu.....	46
3.2.1.1.5.3	Output3 Menu (optional).....	46
3.2.1.1.5.4	Output4 Menu (optional).....	46
3.2.1.1.5.5	Output5 Menu (optional).....	46
3.2.1.1.5.6	Output6 Menu (optional).....	46
3.2.1.1.5.7	Output7 Menu (optional).....	46
3.2.1.1.6	Analog Output Menu (Optional).....	46
3.2.1.1.6.1	Output1 Menu	47
3.2.1.1.6.1.1	Input mode	48
3.2.1.1.6.1.2	Output connection	49
3.2.1.1.6.1.3	Min. value	50

3.2.1.1.6.1.4	Max. value	50
3.2.1.1.6.1.5	Multiplier	50
3.2.1.1.6.2	Output2 Menu	52
3.2.1.1.6.3	Output3 Menu	53
3.2.1.1.6.4	Output4 Menu	53
3.2.1.1.7	Communication Menu.....	53
3.2.1.1.7.1	Baud Rate Menu.....	53
3.2.1.1.7.2	Slave Id	54
3.2.1.1.8	Alarm Menu	54
3.2.1.1.8.1	V(L-N) Menu.....	54
3.2.1.1.8.2	V(L-L) Menu.....	56
3.2.1.1.8.3	Current Menu.....	56
3.2.1.1.8.4	P Menu	56
3.2.1.1.8.5	Q Menu.....	56
3.2.1.1.8.6	S Menu.....	57
3.2.1.1.8.7	CosØ Menu	57
3.2.1.1.8.8	PF Menu	57
3.2.1.1.8.9	IN Menu.....	57
3.2.1.1.8.10	F Menu.....	57
3.2.1.1.8.11	Temp. Menu.....	57
3.2.1.1.8.12	Harmonics V Menu.....	58
3.2.1.1.8.13	Harmonics I Menu	59
3.2.1.1.9	Clear Menu.....	59
3.2.1.2	Date / Time Menu	61
3.2.1.3	System Info Menu.....	61
3.2.1.4	Password Menu	62
3.2.1.5	Restart Menu.....	62
3.2.1.6	Default Settings	63
3.2.2	Measure Menu	63
3.2.2.1	Instantaneous Menu	64
3.2.2.2	Demand Menu	65
3.2.2.2.1	Current Month Menu	66
3.2.2.2.1.1	Current Menu.....	67
3.2.2.2.1.2	Active power menu	68
3.2.2.2.1.3	Reactive power menu.....	68
3.2.2.2.1.4	Apparent power menu.....	68
3.2.2.2.2	1 month Ago Menu.....	68
3.2.2.2.3	2 Months Ago Menu.....	68
3.2.2.2.4	3 Months Ago Menu.....	68
3.2.2.3	Phasor Diagram Menu	69
3.2.2.4	Signals Menu.....	69
3.2.2.5	Harmonics Menu	70
3.2.2.5.1	Table Menu	70
3.2.2.5.2	Graph Menu.....	71
3.2.3	Meters Menu	71
3.2.3.1	Tariff 1 Menu.....	71
3.2.3.1.1	Imp. Active Menu (Import Active Energy Menu).....	72
3.2.3.1.2	Exp. Active Menu (The Consumed Active Energy Menu).....	73

3.2.3.1.3	Imp. reactive Menu (Import Reactive Energy Menu).....	73
3.2.3.1.4	Exp. reactive Menu (Export Reactive Energy Menu).....	73
3.2.3.2	T1 Rate1 Menu.....	74
3.2.3.3	T1 Rate2 Menu.....	74
3.2.3.4	T1 Rate3 Menu.....	75
3.2.3.5	Tariff 2 Menu.....	75
3.2.3.6	Digital Input Menu.....	76
3.2.3.7	Others Menu	76
3.2.4	Alarms Menu	77
3.2.4.1	Phase1 Menu.....	78
3.2.4.2	Phase2 Menu.....	78
3.2.4.3	Phase3 Menu.....	78
3.2.4.4	Other Menu	79
3.2.5	Analysis Menu	79
3.2.5.1	Minimum Menu	80
3.2.5.1.1	Hourly Menu.....	80
3.2.5.1.1.1	Phase1 Menu	80
3.2.5.1.1.2	Phase2 Menu.....	80
3.2.5.1.1.3	Phase3 Menu.....	80
3.2.5.1.1.4	Other	81
3.2.5.1.2	Daily Menu.....	81
3.2.5.1.3	Monthly Menu	81
3.2.5.2	Maximum Menu.....	81
3.2.5.3	Average Menu	81
3.2.5.4	Energy Menu.....	81
3.2.5.4.1	Hourly Menu.....	82
3.2.5.4.2	Daily Menu	82
3.2.5.4.3	Monthly Menu	82

SECTION 4 MODBUS PROTOCOL.....84

4.1	RS485 Wiring Diagram	84
4.2	Computer Connection	84
4.3	Message Format and Data Types of MODBUS-RTU Protocol	85
4.4	Implemented functions for MODBUS-RTU Protocol.....	85
4.5	Data and Setting Parameters for KLEA	86
4.5.1	Measured and Calculated Data	86
4.5.1.1	Alarm Flags	107
4.5.1.2	Digital Input Flags	107
4.5.2	KLEA Setting Parameters	109
4.5.3	ARCHIVE (HISTORY) RECORDS	116
4.5.3.1	Hourly archive data	118
4.5.3.2	Daily archive data	120
4.5.3.3	Monthly archive data	120
4.5.4	Clear	121

FACTORY DEFAULT SETTINGS..... 122

TECHNICAL SPECIFICATIONS..... 126

FIGURES

Figure 1-1	KLEA Display.....	13
Figure 1-2	Four-Quadrant Representation	14
Figure 2-1	Mounting KLEA into the Panel	16
Figure 2-2	Fixing KLEA to the panel	17
Figure 2-3	Loosening of Terminal Block Screws.....	17
Figure 2-4	Inserting Cable into the Terminal Block	18
Figure 2-5	Fixing the Cable to the Terminal Block	18
Figure 2-6	KLEA Star (WYE) Connection Diagram.....	19
Figure 2-7	KLEA 3 Phase Delta Connection Diagram.....	20
Figure 2-8	KLEA Aron Connection Diagram.....	20
Figure 2-9	Digital Output Connection Diagram	21
Figure 2-10	Dimensions.....	21
Figure 3-1	First Power-on Settings	23
Figure 3-2	Dil / Language	23
Figure 3-3	Date	24
Figure 3-4	Example for Setting the Date	24
Figure 3-5	Current Transformer Ratio.....	25
Figure 3-6	Entering Values to the Virtual Keyboard	26
Figure 3-7	Voltage Transformer Ratio.....	27
Figure 3-8	Connection Types.....	27
Figure 3-9	Start.....	28
Figure 3-10	Startup Screen	28
Figure 3-11	Settings Menu.....	29
Figure 3-12	KLEA Save Query.....	30
Figure 3-13	Network Menu.....	30
Figure 3-14	Setting Current Transformer Ratio	30
Figure 3-15	Setting Voltage Transformer Ratio	31
Figure 3-16	Connection	31
Figure 3-17	Demand Period	32
Figure 3-18	Power Unit Setup.....	32
Figure 3-19	Device Menu	33
Figure 3-20	Language Selection.....	33
Figure 3-21	Options for Contrast	34
Figure 3-22	Entering New Password	34
Figure 3-23	Setting Display on Time	35
Figure 3-24	Energy Menu.....	35
Figure 3-25	T1_1 start time.....	36
Figure 3-26	T1_2 start time.....	37
Figure 3-27	T1_3 start time	37
Figure 3-28	Digital Input Menu.....	40
Figure 3-29	Digital Input Menu (With IO option)	40
Figure 3-30	Mode Selection	41
Figure 3-31	Digital Input1 Counter.....	41
Figure 3-32	Delay	42

Figure 3-33	Tariff 1 or Tariff 2 Activation	42
Figure 3-34	Digital Output Menu	43
Figure 3-35	Digital Output Menu (optional digital I/O model).....	43
Figure 3-36	Output1 Menu	44
Figure 3-37	Analog Output Menu	46
Figure 3-38	Output1	47
Figure 3-39	Input mode	48
Figure 3-40	Output connection	49
Figure 3-41	Vout1 -> ON ; lout1 -> OFF	49
Figure 3-42	Vout1 -> OFF; lout1 -> ON	49
Figure 3-43	Multiplier	50
Figure 3-44	Communication Menu.....	53
Figure 3-45	Setting Baud Rate	53
Figure 3-46	Slave Id	54
Figure 3-47	Alarm Menu	54
Figure 3-48	V(L-N) Menu.....	54
Figure 3-49	Alarm Relay Setup	55
Figure 3-50	Alarm Time Setting	55
Figure 3-51	Hysteresis Setting.....	56
Figure 3-52	Alarm Example	56
Figure 3-53	Setting for No Alarm.....	57
Figure 3-54	Invalid Limits message	58
Figure 3-55	Harmonics Menu	58
Figure 3-56	THDV High Limit Setting.....	58
Figure 3-57	V3 - V21 Harmonic High Limit	59
Figure 3-58	Clear Menu.....	59
Figure 3-59	Before Clear	60
Figure 3-60	After Clear	60
Figure 3-61	Initial Value, After Clear Process	60
Figure 3-62	Date / Time Menu	61
Figure 3-63	System Info	61
Figure 3-64	Password.....	62
Figure 3-65	Restart.....	62
Figure 3-66	Default Settings Command	63
Figure 3-67	Measure Menu.....	63
Figure 3-68	Instantaneous Menu	64
Figure 3-69	Connecting the K-L ends of Current Correctly	65
Figure 3-70	Demand Menu.....	65
Figure 3-71	Demand Example	65
Figure 3-72	Current Month Menu	66
Figure 3-73	Example of Current Month Menu	66
Figure 3-74	Current Menu.....	67
Figure 3-75	Phasor Diagram Menu	69
Figure 3-76	Signals Menu.....	69
Figure 3-77	Harmonics Menu	70
Figure 3-78	Harmonics in Table Format	70

Figure 3-79	Harmonics in Graphical Format.....	71
Figure 3-80	Tariff 1 Menu.....	71
Figure 3-81	Imp. Active Energy Page	72
Figure 3-82	Example for Start of Hour	72
Figure 3-83	Example for Start of Day	72
Figure 3-84	Example for Start of Month.....	73
Figure 3-85	T1 Rate1 Menu.....	74
Figure 3-86	T1 Rate2 Menu.....	74
Figure 3-87	T1 Rate3 Menu.....	75
Figure 3-88	Tariff 2 Menu.....	75
Figure 3-89	Digital Input Menu (Optional Digital I/O model)	76
Figure 3-90	Alarms Menu	77
Figure 3-91	Phase1 Menu	78
Figure 3-92	Other Menu	79
Figure 3-93	Analysis Menu.....	79
Figure 3-94	Minimum Menu	80
Figure 3-95	Hourly Menu.....	80
Figure 3-96	Energy Menu	81
Figure 4-1	RS485 Wiring Diagram.....	84
Figure 4-2	Connection of KLEA to a PC.....	84

TABLES

Table 4-1	Message Format.....	85
Table 4-2	int (32 bit) data type.....	85
Table 4-3	Implemented functions for MODBUS RTU Protocol	85
Table 4-4	Read-only Data.....	87
Table 4-5	Data and Setting Parameters for KLEA.....	109
Table 4-6	Description List	115
Table 4-7	Archive (History) Record Table.....	116
Table 4-8	Clear Address Table.....	121

A decorative graphic consisting of a cluster of interconnected circles in orange and dark blue. The circles are arranged in a pattern that resembles a molecular structure or a network. Some circles are solid, while others are hollow with a white outline. The overall shape is roughly triangular, pointing towards the top right.

**SECTION 1
GENERAL
INFORMATION**

SECTION 1 GENERAL INFORMATION

1.1 Symbols

Caution:

Wherever used, this symbol indicates that there is important information that must be taken into consideration.

**Danger of Electric Shock:**

This symbol indicates that there is dangerous voltage or current.

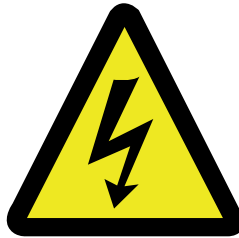

1.2 General Warnings

- Do not work under live supply conditions. Before installation, turn off the power of the panel or any other related equipment.
- Installation, operation and commissioning (putting into service) of KLEA must be performed by qualified personnel.
- The device must be put into service only after all connections are made.
- KLEA is connected to current transformer(s). Before disconnecting current transformer leads, be sure that they are short circuited elsewhere or connected to a parallel load which has sufficiently low impedance. Otherwise dangerously high voltages will be induced at the current transformer leads. Same phenomena also apply for putting into service.
- Keep and store away from moisture, dust, vibration and wet environment.
- For cleaning, remove the dust with a dry cloth. Do not use abrasives, solvents or alcohol.
- There are no user serviceable parts inside. Maintenance and calibration can only be carried out at manufacturer's end.
- It is recommend to connect circuit breakers or automatic fuses between voltage inputs of Klea and the network.

1.3 Receipt Control and Contents of Delivery

When you receive the package, please be sure that,

- packing is in good condition,
- product has not been damaged during transportation,
- product name and reference (order) number conforms to your order.

KLEA Order Number:	Statement:
606100	Klea base model
606101	Klea optional digital IO model
606102	Klea optional 2 analog outputs model
606103	Klea optional 4 analog outputs model
606121	Klea 7 different energy meter
606150	Klea base model + DC power supply(18...60VDC)

Please also check the contents of delivery as listed below:

- 1 pc. KLEA
- 1 pc., CD-ROM (User manual and KleaCom software)
- 2 pcs., fixing brackets and screws
- 1 pc., 4-pin female terminal block for alarm outputs (NO, C/out2, C/out1, NO)
- 1 pc., 6-pin female terminal block for current inputs (I1 , k1 , I2 , k2 , I3 , k3)
- 1 pc., 3-pin female terminal block for supply input (Un)
- 1 pc., 3-pin terminal block for digital inputs (DI1, GND, DI2)
- 1 pc., 4-pin female terminal block for voltage inputs (L1 , L2 , L3 , N)
- 1 pc., 7-pin female terminal block for digital output and RS485 (B, GND1, A, DO1+, DO1-, DO2+, DO2-)
- 2 pcs., 10-pin female terminal block for digital IO optional (KLEA - 606101) product (DO3+, DO3- ...), (DI3, GND3...)
- 1 pc., 4-pin female terminal block for two analog output optional (KLEA - 606102) product (AO1-GND, AO2-GND)
- 1 pc., 8-pin female terminal block for four analog output optional (KLEA - 606103) product (AO1-GND, ..., AO4-GND)

1.4 KLEA Energy Analyzer

KLEA is a multi functional energy analyzer.

KLEA,

- measures/calculates
 - » current, voltage and frequency
 - » active, reactive and apparent power
 - » Current and voltage harmonics up to 51. harmonic
 - » THDV, THDI
 - » Power factor, $\cos\varnothing$

for each phase.

- KLEA has “1st tariff” and “2nd tariff” meters. These meters record “Imp. Active”, “Exp. Active”, “Import Reactive” and “Export Reactive” energy values.
- There is an isolated RS485 port in KLEA.
- KLEA’s 1st Tariff and 2nd Tariff energy values can be assigned to digital outputs.
- It has 2 pieces of relay outputs.

Besides, KLEA has numerous features such as;

- Setting alarms for various measurement parameters,
- Monitoring official energy meters by means of assigning initial values for Klea tariff meters,
- Compatibility for 3 phase/3 wire, 3 phase/4wire or aron connected systems,
- Avoiding unauthorized control by a 4-digit password.

KLEA Energy Analyzer has,

- 2 programmable alarm relay outputs, 2 digital outputs (totally 7 pieces in optional digital IO model), 2 digital input (totally 7 pieces in optional digital IO model), 1 piece of RS-485 communication port, 2/4 analog outputs (optional), battery supported real-time clock and memory.
- There are 6 keys and 160x240 graphical LCD on the front panel. By means of them, device settings and monitoring of measurement values can easily be accomplished.

1.5 KleaCom Software

Operator can remotely reach a Klea device via KleaCom software.

KleaCom software can communicate with only one Klea at the same time; operator can reach other Klea devices on the same network by changing the slave ID.

All measured/calculated parameters can be monitored with KleaCom. All settings of Klea can be changed/read via KleaCom software.

History (archive) data of Klea can be downloaded using KleaCom and this data can be listed in an MS Excel or WordPad file (selectable).

KleaCom software is included in the CD-ROM received with Klea package.

Latest version of KleaCom software can be downloaded from www.klemsan.com.tr

1.6 KLEA Front Panel

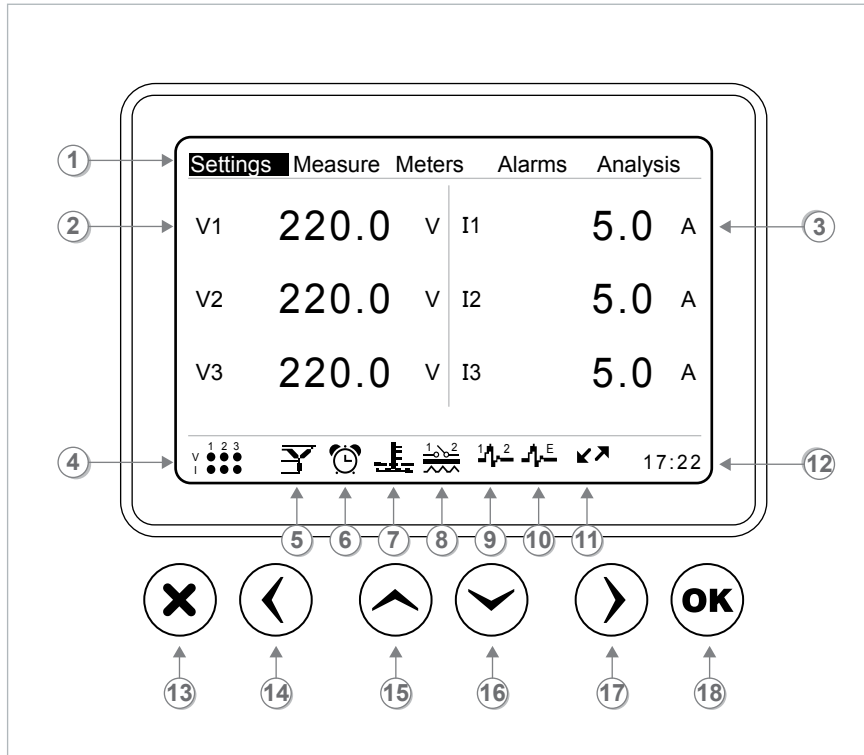

Figure 1-1 KLEA Display

- 1 Menu
- 2 L-N voltages belonging to three phases
- 3 Currents of three phases
- 4 Presence/Absence of currents-voltages belonging to three phases, and phase sequence
- 5 Selected connection type
- 6 Alarm state symbol (for any alarm)
- 7 Temperature alarm state symbol (displayed only with a temperature alarm)
- 8 Alarm relay symbol (If 1st and/or 2nd alarm relay is assigned to any alarm and also if there is an alarm in the system at the same time, this symbol shall appear on the screen. "1" stands for 1st Alarm Relay and "2" stands for 2nd Alarm Relay)
- 9 KLEA digital output symbol ("1" indicates, digital output 1; and "2" indicates digital output 2. This symbol shall be displayed as long as width of the output pulse.)
- 10 KLEA digital output symbol (if there is an output from optional output3, output4, output5, output6 and output7, this symbol shall be displayed.)
- 11 RS485 communication symbol
- 12 Klea system time
- 13 X Key (in order to cancel any change or to return to the upper menu)
- 14 Left key
- 15 Up key
- 16 Down key
- 17 Right key
- 18 OK key (pressed in order to save any change or to access submenus)



1.7 Four-Quadrant Representation

The angle(\emptyset) between voltage and current provides us information about the direction of energy flow. A positive sign for active/reactive power indicates that active/reactive power is consumed. And also a negative sign for active/reactive power indicates that active/reactive power is generated.

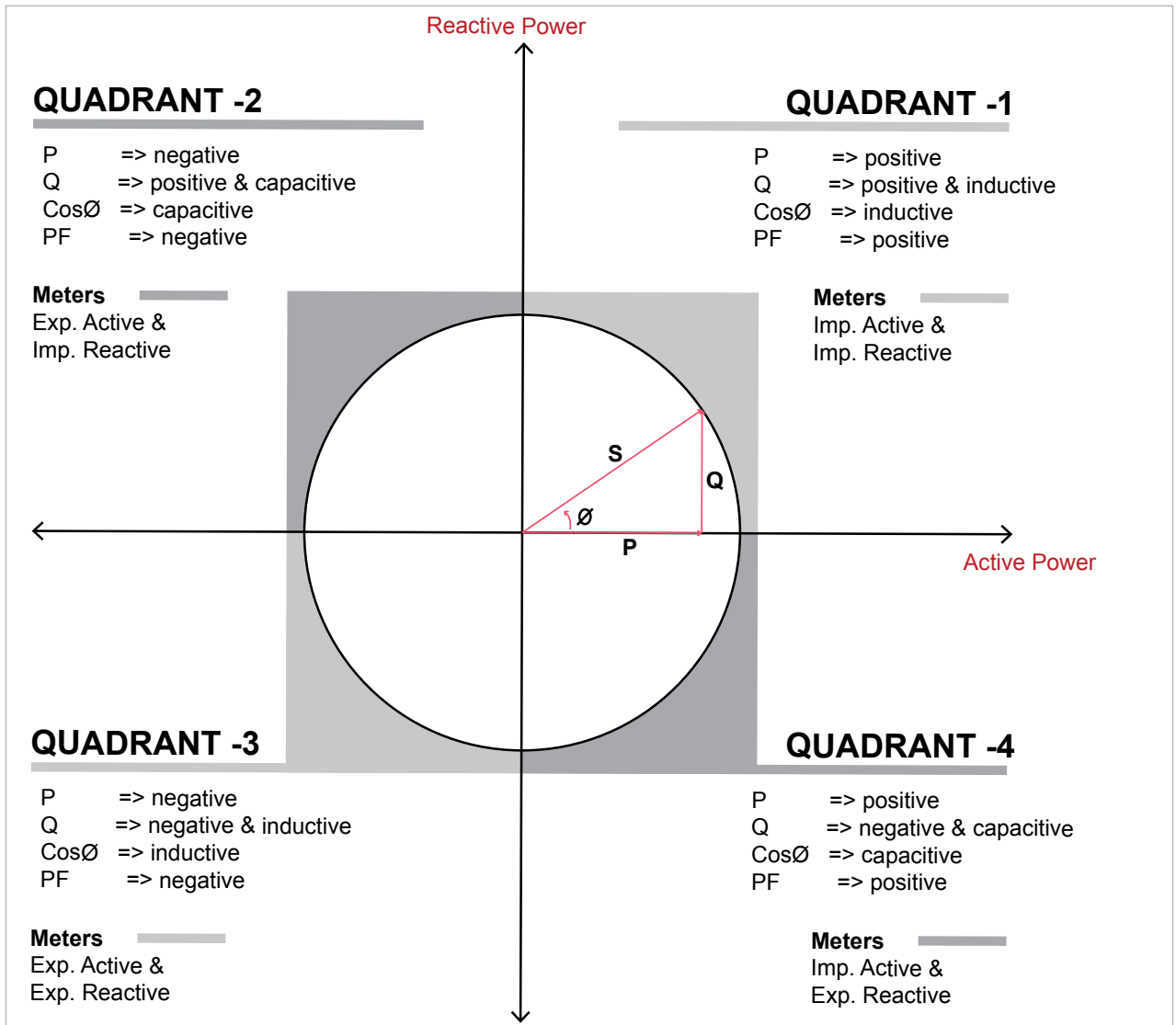
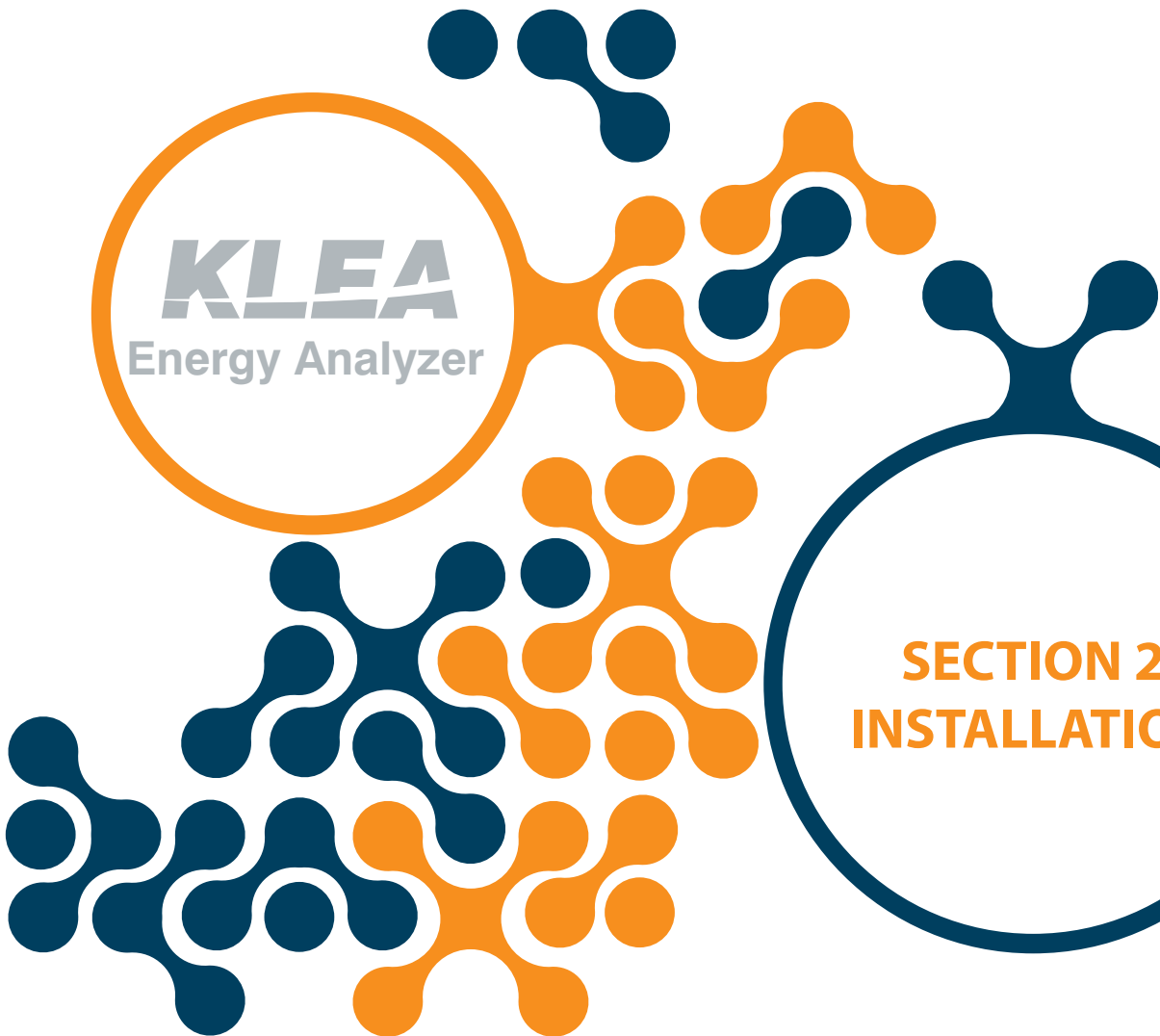

Figure 1-2 Four-Quadrant Representation

NOTE: If the signs of active and reactive power are examined, it can be defined the quadrant that Klea measures.

e.g.

- P= +10kWh, Q= +5kVAr => Quadrant-1
- P= -10kWh, Q= +5VAr => Quadrant-2
- P= -10kWh, Q= -5kWh => Quadrant-3
- P= +10kWh, Q=-5kWh => Quadrant-4



SECTION 2 INSTALLATION

This section provides the information about installation, mounting, cable routing and connections of Klea.

2.1 Preparing for Installation

The purchased KLEA may not include all hardware options referred in this document. This situation does not constitute an impediment to the electrical installation.



Assembly and related connections of KLEA, must be implemented by authorized persons in accordance with the instructions of user manual.



The device must not be put into service if the operator is not sure that all connections are correctly accomplished.

2.2 MOUNTING

KLEA is placed vertically into the gap located in the panel.

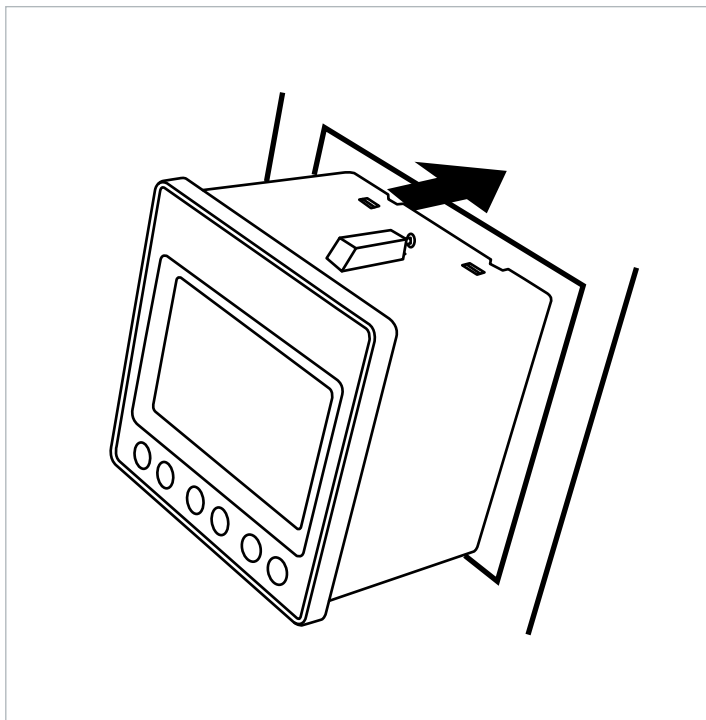

Figure 2-1 Mounting KLEA into the Panel

After the KLEA is placed into the panel, fixing brackets should be installed on Klea and Klea should be fixed to the panel wall with the screws.

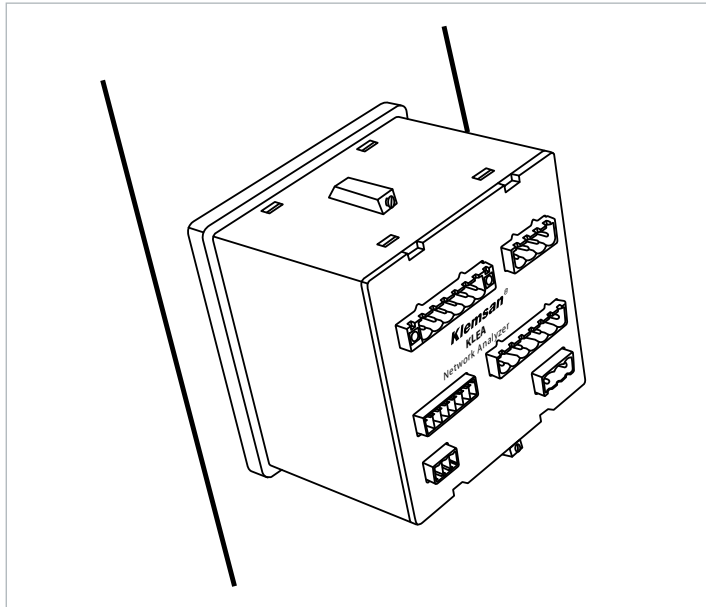

Figure 2-2 Fixing KLEA to the panel

There are 2.5mm² and 1.5mm² screwed female terminal blocks connected to fixed male terminal blocks on KLEA. Remove female terminal blocks and loosen their screws.

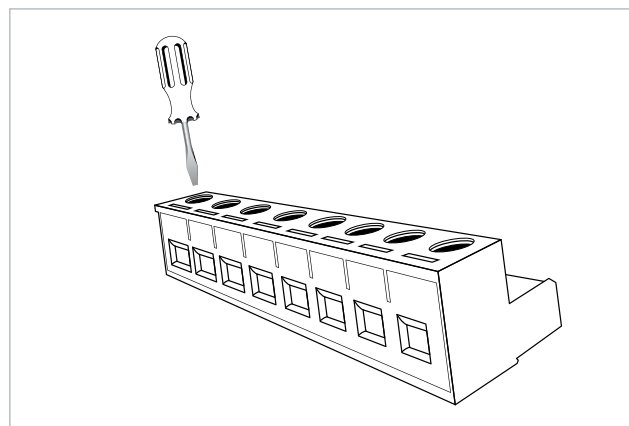

Figure 2-3 Loosening of Terminal Block Screws



Before wiring up voltage and current ends to KLEA, you must be sure that the power is cut.



KLEA is connected to current transformer(s). Before disconnecting current transformer leads, be sure that they are short circuited elsewhere or connected to a parallel load which has sufficiently low impedance. Otherwise dangerously high voltages will be induced at the current transformer leads. Same phenomena also apply for putting into service.

The cable is placed into the related opening.

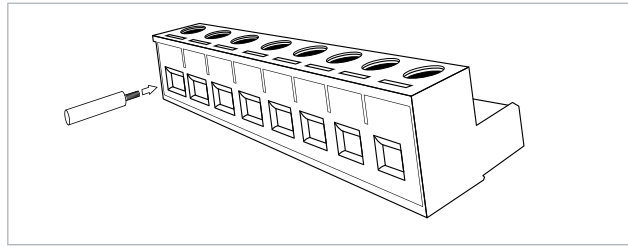

Figure 2-4 Inserting Cable into the Terminal Block

After the cable is placed, the screws are tightened and the cable is fixed.

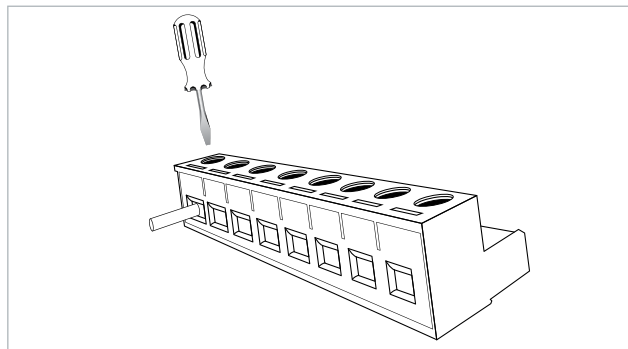

Figure 2-5 Fixing the Cable to the Terminal Block

The Terminal Block is inserted into its seat located on KLEA.



If KLEA is used together with current transformers, please pay attention to the following warning.

Threshold values for proper operation of current transformers differ according to the type and size of the transformers being used.

Before applying the points mentioned in the following warning, please check that the measured current value is larger than the current threshold value of the current transformer (Refer to manual or datasheet of the current transformer).

For both of the warnings below, there must be a current in the system which is higher than the threshold value of the current transformer (if any).



If KLEA is placed in a panel which consumes power;

The signs on Measure/Instantaneous/Active Power screen, should be positive, as the phases consume power.

If there is a negative sign, turn off the device, cut off the panel power and then cross connect K and L ends of the current inputs belonging to the related phase(s). After that, check that all values are positive on Measure => Instantaneous => Active Power screen.



If KLEA is placed in a panel which generates power; The signs on Measure/Instantaneous/Active Power screen, should be negative, as the phases generate power.
If there is a positive sign, turn off the device, cut off the panel power and then cross connect K and L ends of the current inputs belonging to the related phase(s). After that, check that all values are negative on Measure => Instantaneous => Active Power screen.

2.3 Wiring Diagrams

2.3.1 Three Phase Connection With Neutral (3P4W)

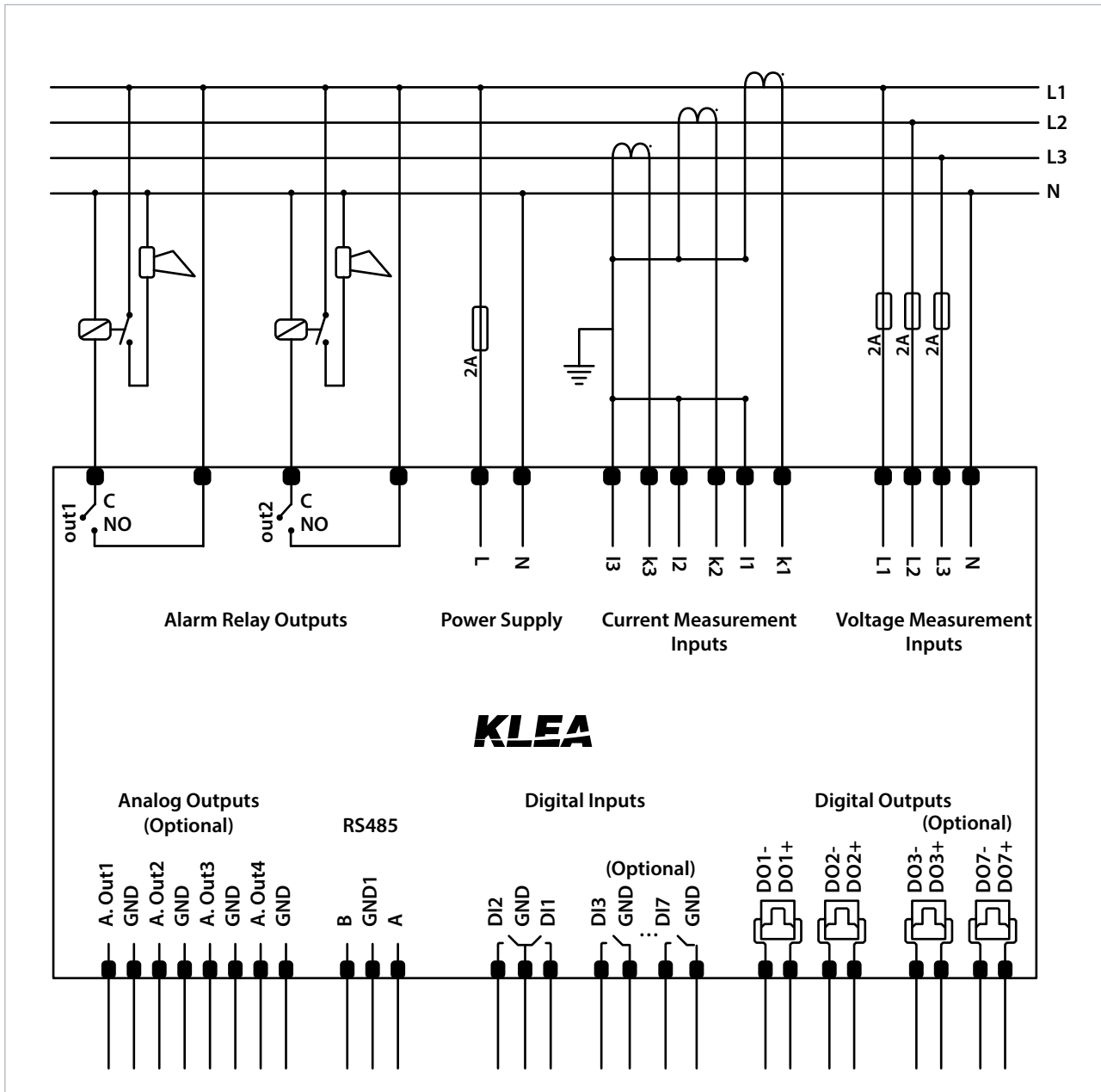

Figure 2-6 KLEA Star (WYE) Connection Diagram

2.3.2 Three Phase Connection No Neutral (3P3W)

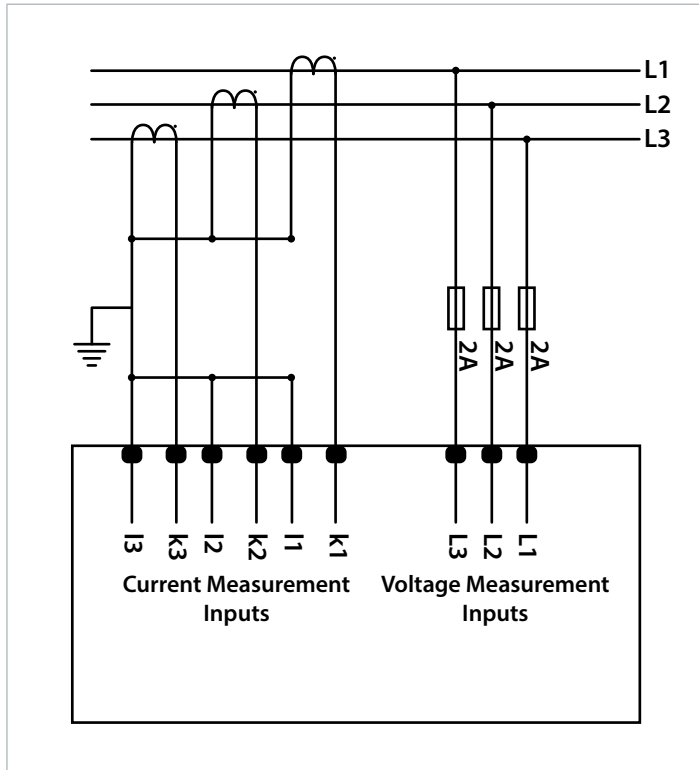

Figure 2-7 KLEA 3 Phase Delta Connection Diagram

2.3.3 Three Phase No Neutral Aron Connection

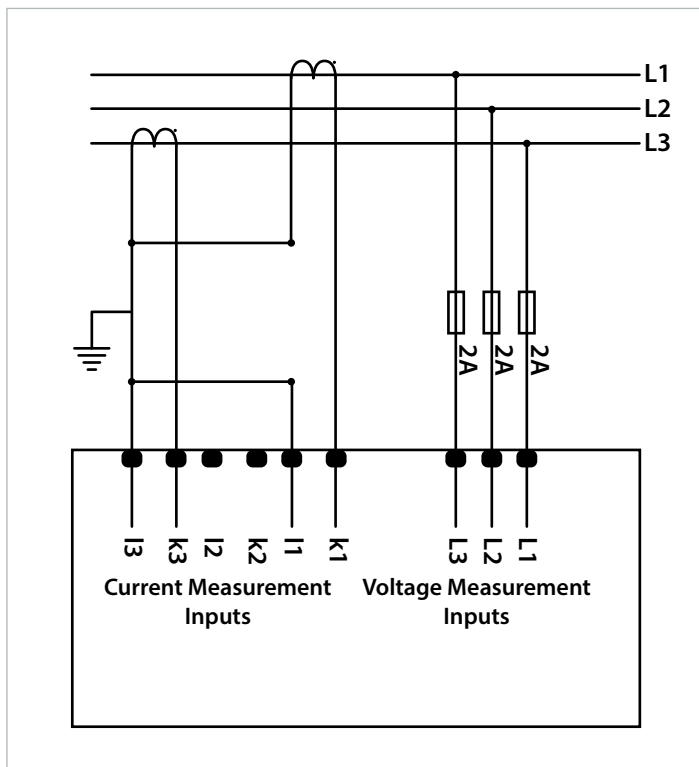

Figure 2-8 KLEA Aron Connection Diagram

2.3.4 Digital Output Connection Diagram

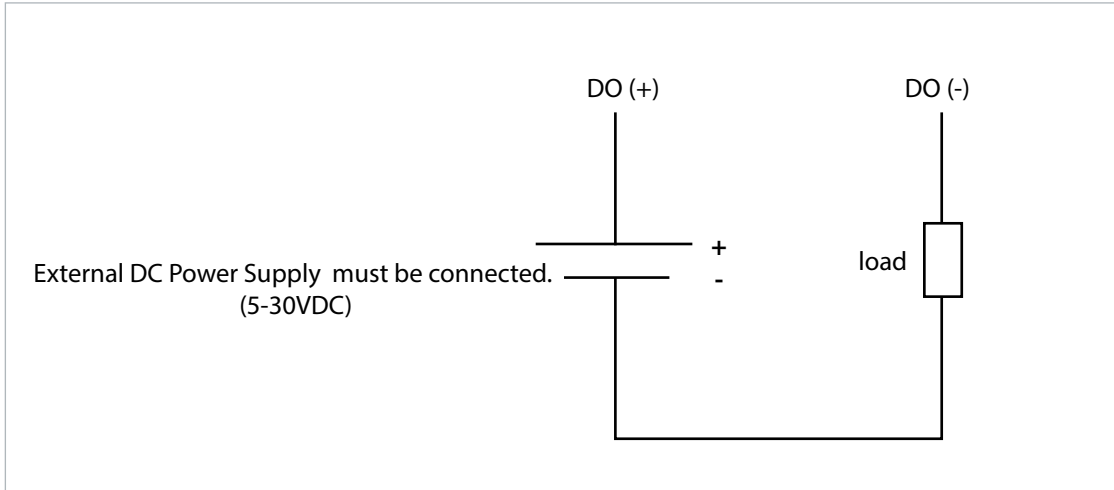

Figure 2-9 Digital Output Connection Diagram

2.4 Dimensions

Dimensions are in millimeters.

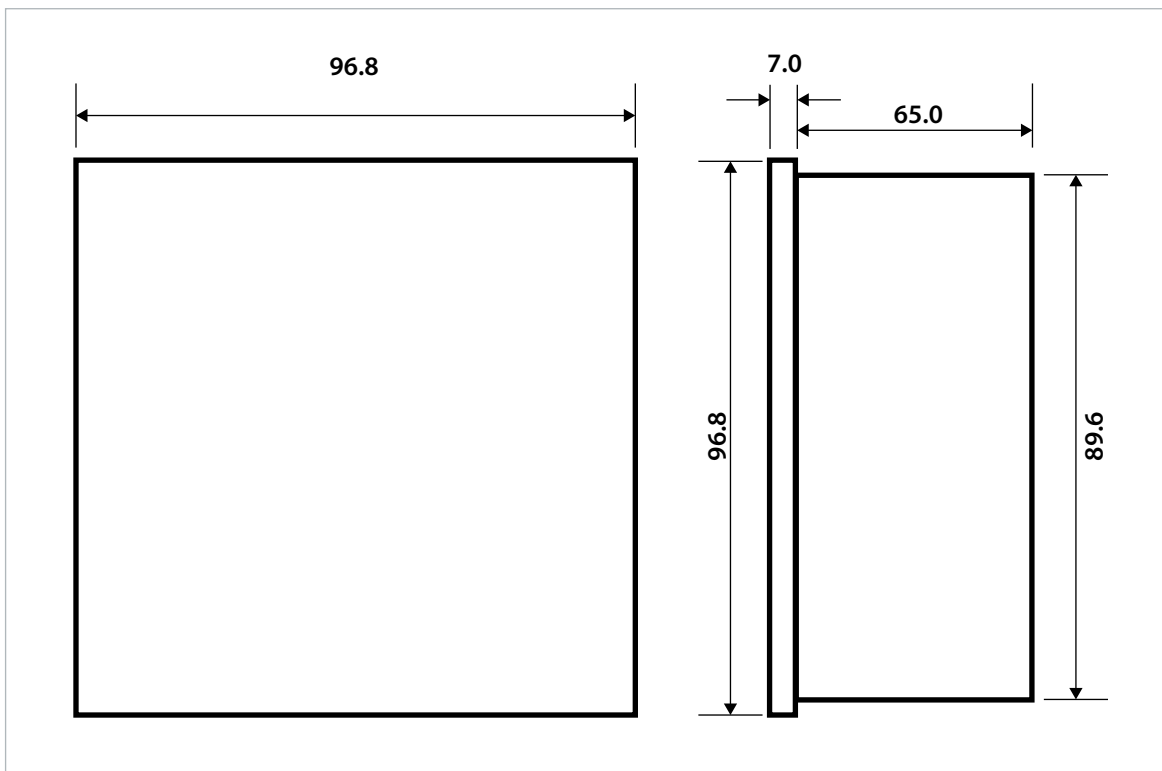
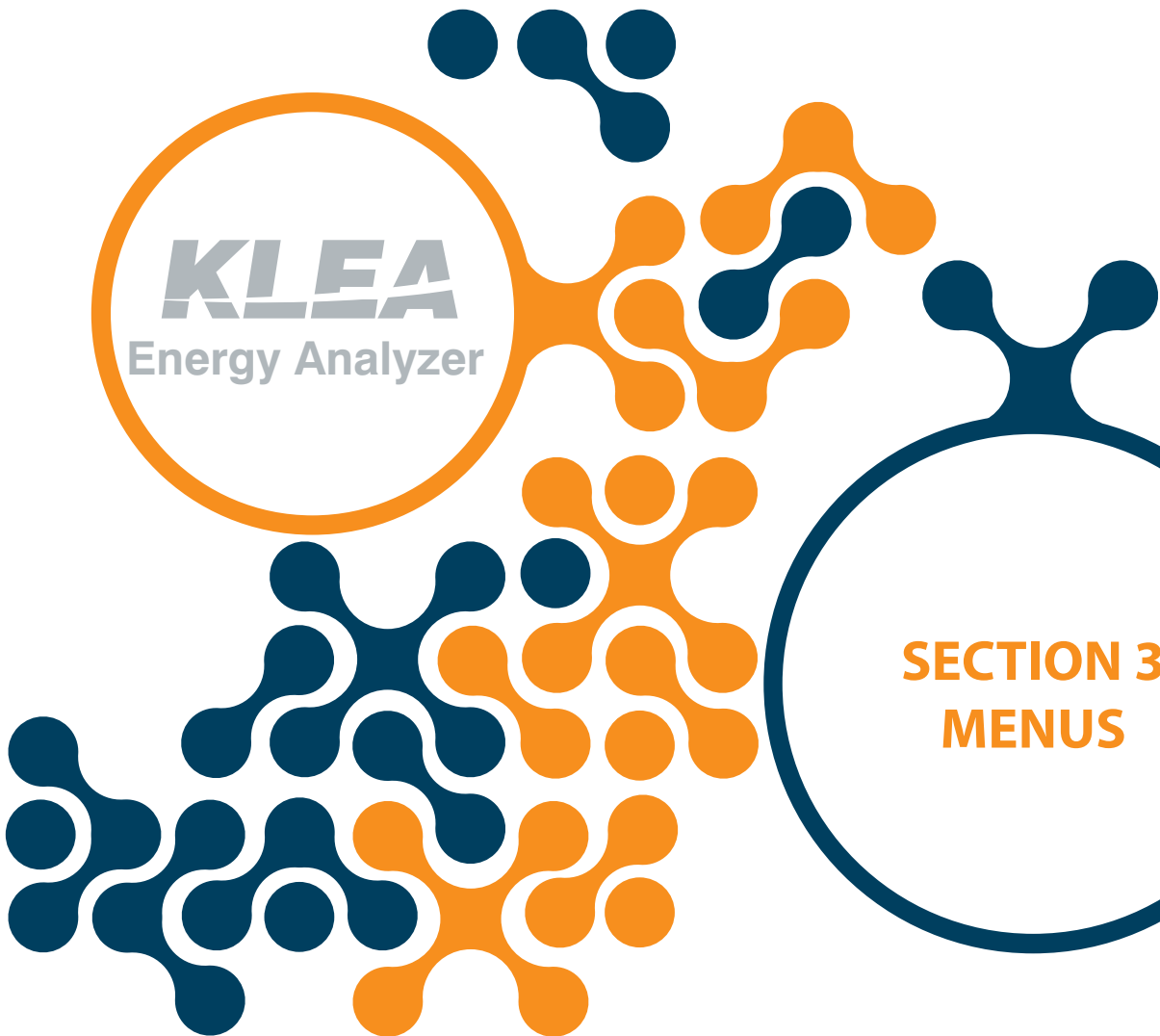
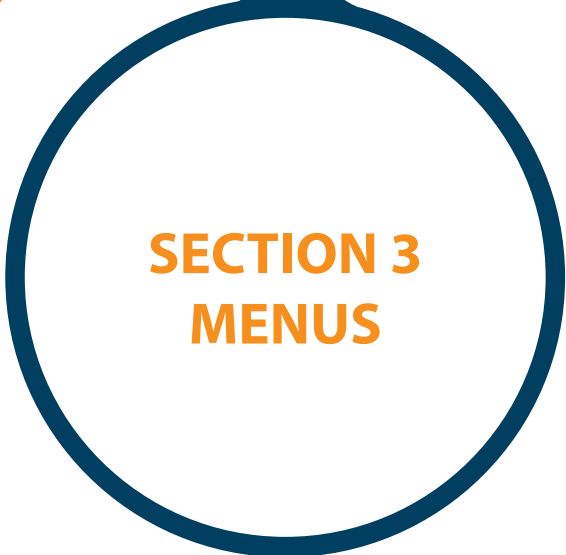

Figure 2-10 Dimensions



SECTION 3 MENUS

3.1 "First Power-on" Settings

After its receipt, when KLEA is switched on "for the first time", the following page appears.

Startup Settings	
Language	English
Date	07 January 2013
Time	17:45:28
CTR	1
VTR	1.0
Connection	3phase 4wire
Start	

Figure 3-1 First Power-on Settings

3.1.1 Dil / Language

When OK key is pressed on this tab, "Türkçe", "English" and "Русский" options appear on the screen as seen below. Operator can scroll inside the options by pressing up and down keys and then should press "OK" to select the desired option. If language is selected as English, other tabs within this page will also be in English.

Startup Settings	
Language	English
Date	07 Jan
Time	17:45
CTR	1
VTR	1.0
Connection	3phase 4wire
Start	

Startup Settings	
Language	English
Date	07 January 2013
Time	17:45:28
CTR	1
VTR	1.0
Connection	3phase 4wire
Start	

Figure 3-2 Dil / Language

3.1.2 Date

In order to change the date, operator should press OK key, when "Date" tab is highlighted. Press right and left to move between day, month and year entries. Press up and down keys to change the values. Press OK key to complete date setting.

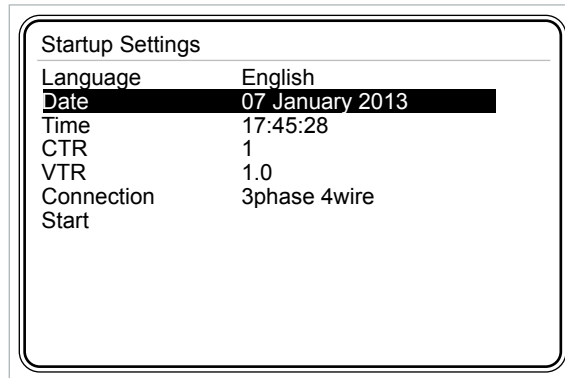

Figure 3-3 Date

Example: In order to enter "7 January 2013":

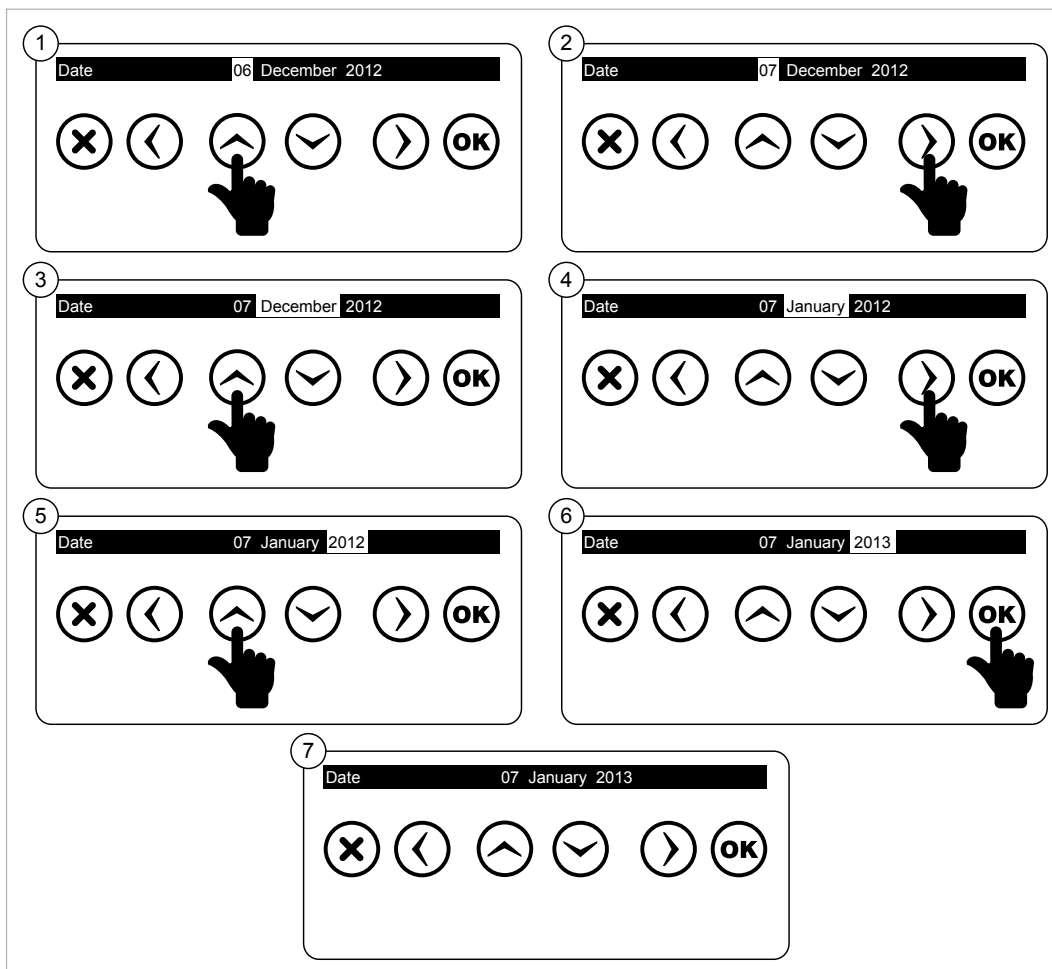

Figure 3-4 Example for Setting the Date

3.1.3 Time

Time setting for KLEA is accomplished as explained in [3.1.2 Date](#) menu.

3.1.4 Current Transformer Ratio (CTR)

In this tab, current transformer ratio is entered. The current transformer ratio can be adjusted between 1-5000. When this tab is highlighted; if the operator presses OK key, KLEA Virtual Keyboard will appear on the screen.

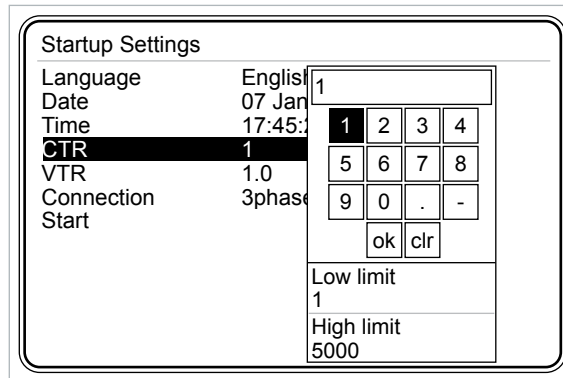

Figure 3-5 Current Transformer Ratio

Use arrow keys (left, right, up and down) of Klea to navigate inside the virtual keyboard. In order to enter any number in the virtual keyboard as a value, when that number is highlighted, press OK key of Klea. When 'ok' box of virtual keyboard is highlighted, press 'OK' key of Klea to complete current transformer setting.

In case an incorrect digit is entered, scroll inside the virtual keyboard to select **clr** box. Then pres 'OK' key of Klea to erase erroneous entered digit(s).



In order for KLEA to perform accurate measurements, current transformer ratio should be entered correctly.

Example:

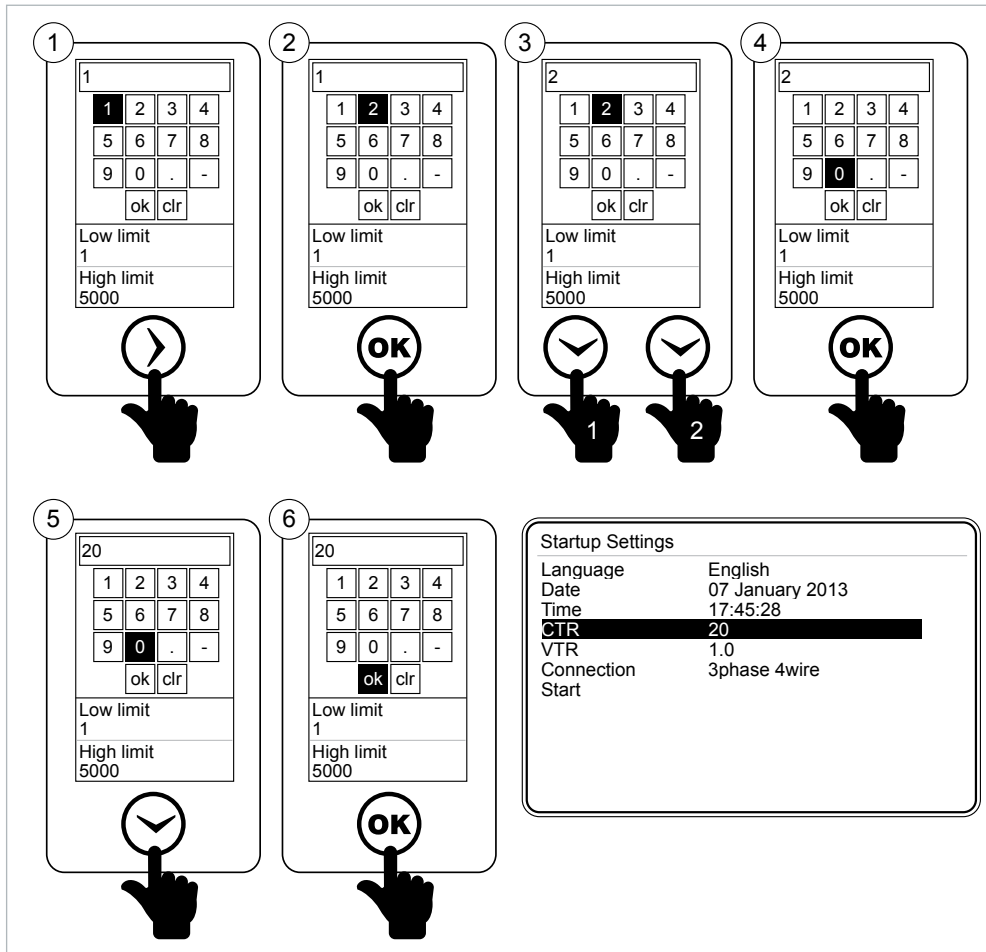

Figure 3-6 Entering Values to the Virtual Keyboard



To enter a decimal value, enter the integer part of the decimal number first. Then scroll inside virtual keyboard till box is highlighted. Press OK key of Klea to insert the decimal point. Following the point, enter the decimal part of the desired value.



To enter a negative value, enter the number, move inside the virtual keyboard point to the negative sign box and press OK.

3.1.5 Voltage Transformer Ratio (VTR)

In this tab voltage transformer ratio is entered. (For Virtual Keyboard Refer to 3.1.4 Example). The voltage transformer ratio can be adjusted between 1 - 5000.

To enter a decimal value, enter the integer part of the decimal number first. Then scroll inside virtual keyboard till box is highlighted. Press OK key of Klea to insert the decimal point. Following the point, enter the decimal part of the desired value.

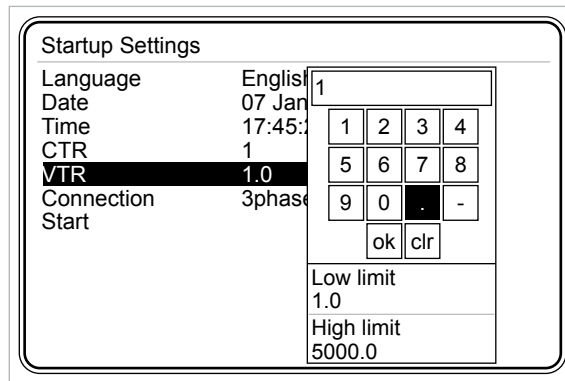

Figure 3-7 Voltage Transformer Ratio



In order for KLEA to perform accurate measurements, current transformer ratio should be entered correctly.

3.1.6 Connection

This menu contains information about how to connect KLEA to the panel/electrical network.

There are 3 connection types:

- 3 phase – 4 wire connection
- 3 phase – 3 wire connection
- Aron connection

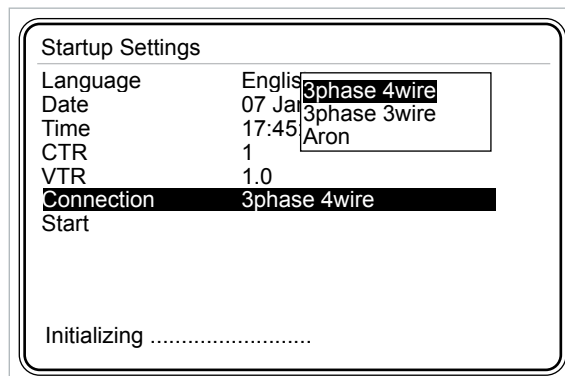

Figure 3-8 Connection Types

3.1.7 Start

When Start tab is selected, press OK key to initialize Klea.

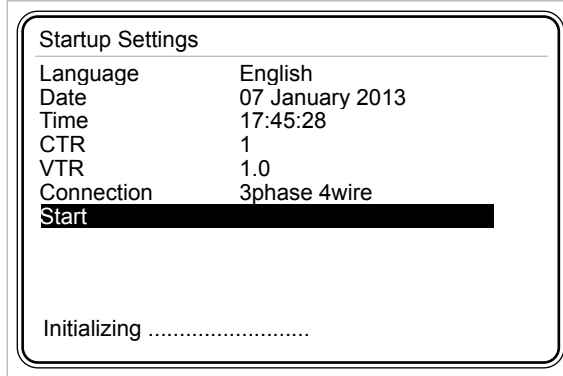

Figure 3-9 Start



KLEA “first power-on” settings page only appears when KLEA is powered up for the first time after factory production. Following this first initialization, all the required settings (including “first power-on” page settings) can be accomplished via Settings menu of KLEA.

3.2 Startup Screen

After KLEA is turned on, following page appears.

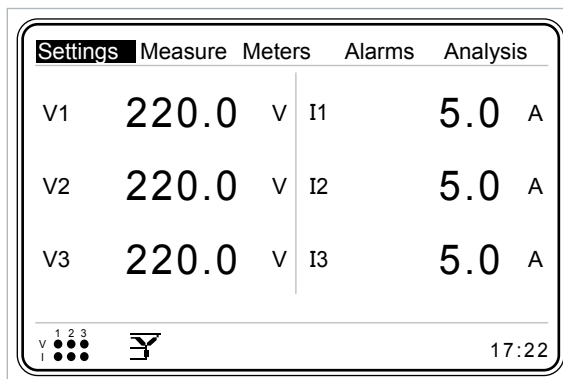

Figure 3-10 Startup Screen

At the top of the screen, there are multiple selection menus.

In the middle, instantaneous voltage and current values pertaining to each phase are shown.

At the bottom left of the screen, current and voltage values of the three phases and connection type are shown.

At the bottom right corner, system clock (KLEA time) is shown.

Operator can navigate between the multiple selection menus by pressing right and left arrow keys. Press OK key to enter into any multiple selection menu.



When 3phase-4wire or ARON connection is selected, VL-N voltages are shown in startup screen.
When 3phase-3wire connection is selected, VL-L voltages are shown in startup screen

3.2.1 Settings

KLEA settings are made in this menu. Select Settings menu and press OK key. When OK key is pressed, submenus will appear as seen in the Figure 3-11. Under the Settings menu, the following submenus exist.

- Setup
- Date/Time
- System info
- Password
- Restart
- Default Settings

Settings	Measure	Meters	Alarms	Analysis
Setup				
Date / Time	0	V	I1	5.0 A
System info				
Password				
Restart	0	V	I2	5.0 A
Default settings				
V3	220.0	V	I3	5.0 A

Figure 3-11 Settings Menu

3.2.1.1 Setup Menu

The following submenus are available inside Setup menu:

- Network
- Device
- Energy
- Digital input
- Digital output
- Communication
- Alarm
- Clear

The user can scroll inside the menus by pressing up and down keys. Press OK key in order to access contents of each submenus (the submenus under the setup menu) .

In order for the new settings to be accepted by KLEA and stored in the memory, operator should navigate back (by pressing X key) to Startup Screen from the tab at which change has been made. When the operator returns to Startup page, "Settings changed. Save?" message will appear on the screen. If OK is pressed, changes will be accepted and stored in permanent memory. If X key is pressed, the changes will not be accepted by KLEA and will not be stored in permanent memory.



When “Settings changed. Save?” message appears on KLEA screen; if OK is pressed, setting changes will be accepted and stored in permanent memory. If X key is pressed, the changes will not be accepted and will not be stored in permanent memory.

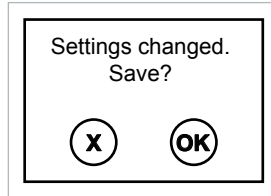

Figure 3-12 KLEA Save Query

3.2.1.1.1 Network Menu

Electrical network related settings are accomplished in this menu.

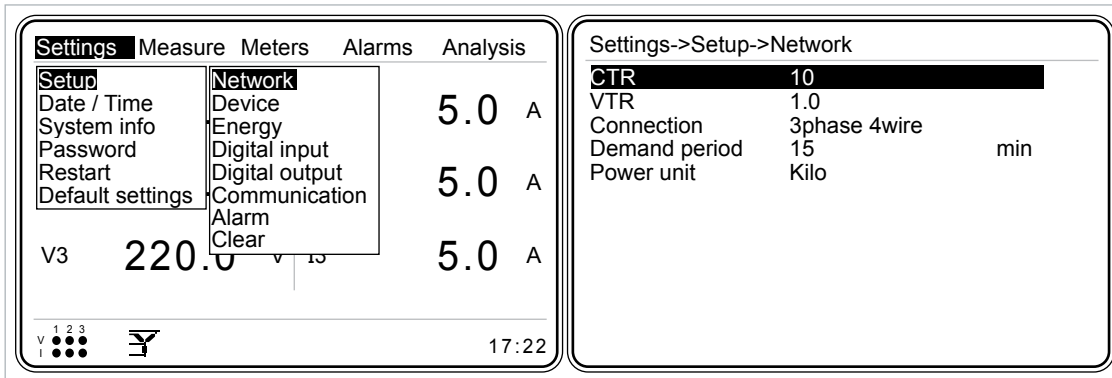

Figure 3-13 Network Menu

3.2.1.1.1.1 Current Transformer Ratio

In this submenu current transformer ratio is entered. Inside Network menu, press up and down keys to select CTR. Press OK key and KLEA virtual keyboard will appear on the screen. The current transformer ratio (CTR) can be adjusted between 1 - 5000. (For Virtual Keyboard Refer to 3.1.4 Example)

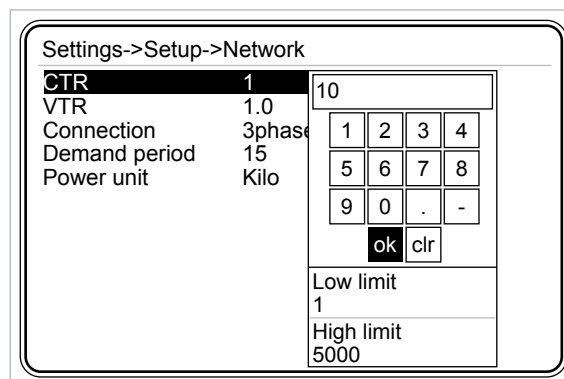

Figure 3-14 Setting Current Transformer Ratio



In order for KLEA to perform accurate measurements, current transformer ratio should be entered correctly.

3.2.1.1.1.2 Voltage Transformer Ratio

In this submenu voltage transformer ratio is entered. Inside Network menu, press up and down keys to select VTR. Press OK key and KLEA virtual keyboard will appear on the screen. The voltage transformer ratio (VTR) can be adjusted between 1 - 5000. (For Virtual Keyboard Refer to 3.1.4 Example). If a decimal number is to be entered as a VTR, with the help of Klea arrow keys point to the box on the Virtual Keyboard and press OK key.



In order for KLEA to perform accurate measurements, the voltage transformer ratio should be entered correctly.

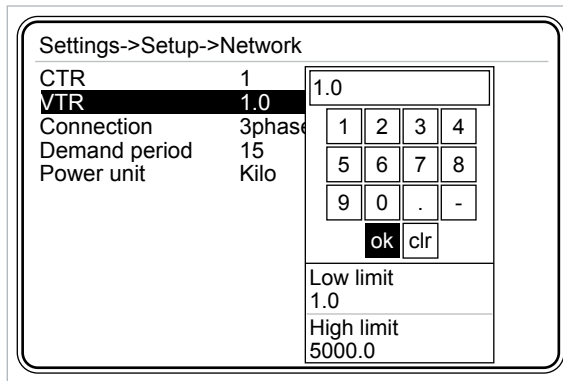

Figure 3-15 Setting Voltage Transformer Ratio

3.2.1.1.1.3 Connection

KLEA may perform measurements with three different connection types.

- 3 phase – 4 wire connection
- 3 phase – 3 wire connection
- Aron connection

Inside Network menu, press up and down keys to select Connection. Press OK key and the above connection types will appear on the screen. Select the connection type and press OK to finish the setting.

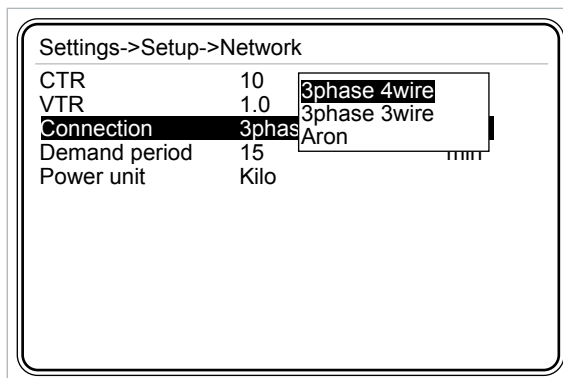

Figure 3-16 Connection

3.2.1.1.1.4 Demand Period

Inside Network menu, press up and down keys to select (highlight) 'Demand period' menu item. When 'Demand period' is selected, press OK key and KLEA virtual keyboard will appear on the screen. Demand period can be adjusted between 1 - 60 minutes. (For Virtual Keyboard Refer to 3.1.4 Example)

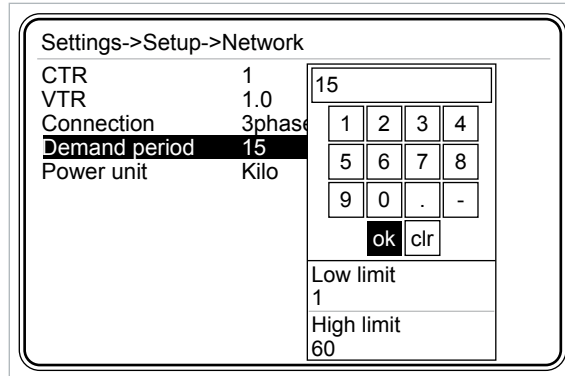

Figure 3-17 Demand Period

3.2.1.1.1.5 Power Unit

KLEA displays total power or total energy values in two different units:

- Kilo
- Mega

Inside Network menu, press up and down keys to select (highlight) 'Power unit' menu item. When 'Power unit' is selected, press OK key and the aforementioned options will appear on the screen. Press up and down keys to select the desired option and press OK key to complete the setting.

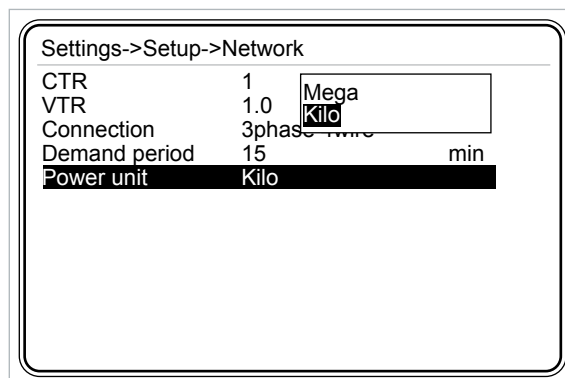

Figure 3-18 Power Unit Setup

3.2.1.1.2 Device Menu

In this menu following settings can be accomplished.

- Language
- Contrast
- New Password
- Display on
- Display on Time

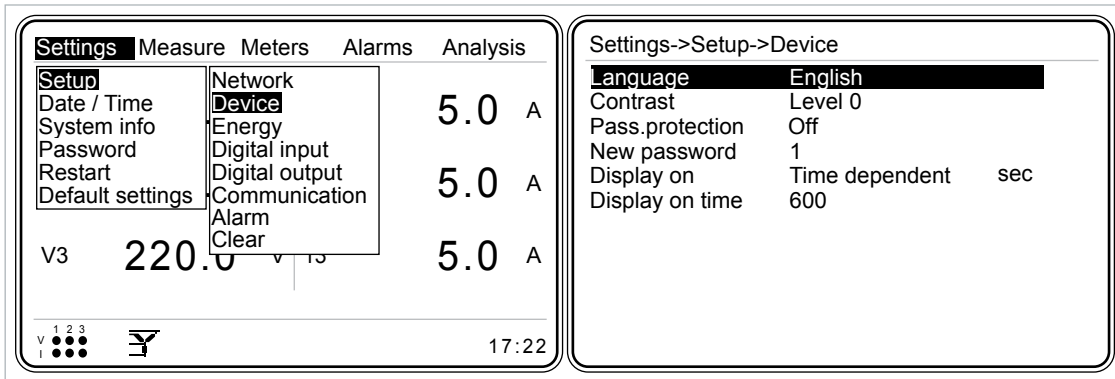

Figure 3-19 Device Menu

3.2.1.1.2.1 Language

Inside Device menu, press up and down keys to select (highlight) 'Language' menu item. When 'Language' is selected, press OK key and the options in Figure 3-20 will appear on the screen. Press up and down keys to select the desired option and press OK key to complete the setting.

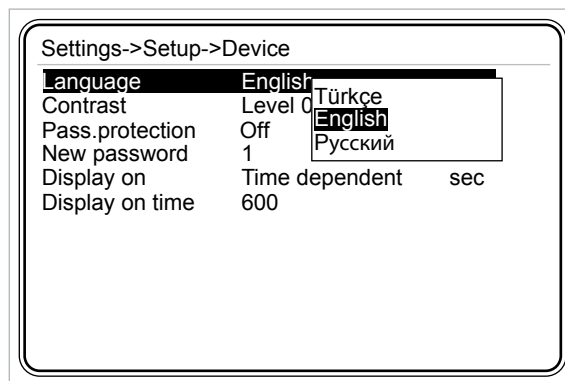

Figure 3-20 Language Selection

3.2.1.1.2.2 Contrast

Inside Device menu, press up and down keys to select (highlight) 'Contrast' menu item. Press OK key and contrast levels will appear on the screen as seen in Figure 3-21. Scroll inside contrast levels by pressing up and down keys; press OK key to select the desired option. Graphical LCD of KLEA darkens towards the Level 4; and lightens towards the Level -4.

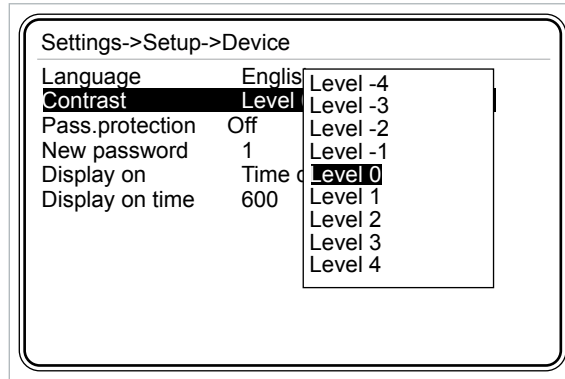

Figure 3-21 Options for Contrast

3.2.1.1.2.3 Password Protection and New Password

KLEA has a password protection and default password protection is "Off". Default password is "1". New password can be adjusted between 1 - 9999 (For Virtual Keyboard Refer to 3.1.4 Example).

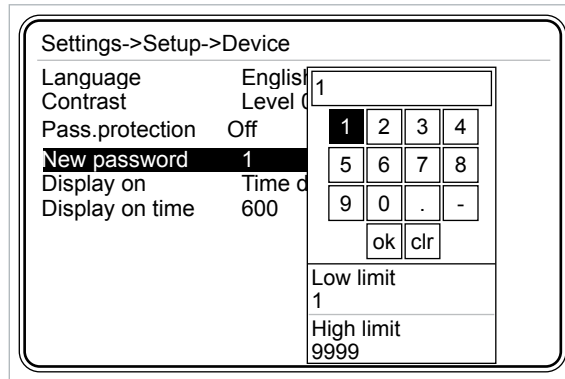

Figure 3-22 Entering New Password

3.2.1.1.2.4 Display on Selection

- Continuous
- Time dependent

If continuous is selected, the backlight of KLEA graphical LCD will be turned on continuously. If 'Time dependent' option is selected, the backlight of the graphical LCD remains open as long as "display on time".

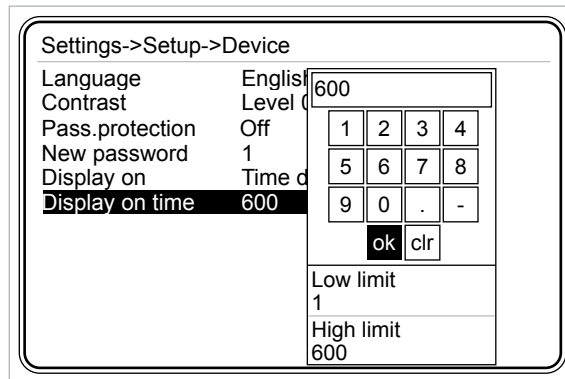

Figure 3-23 Setting Display on Time

3.2.1.1.2.5 Display on Time

Display on time can be adjusted between 10 - 600 seconds. (For Virtual Keyboard [Refer to 3.1.4 Example](#)).

3.2.1.1.3 Energy Menu

Initial energy values for T1, T1_1, T1_2, T1_3 and T2 can be entered inside this menu. Thus, operator can synchronize the official electric meter with KLEA tariff meters. Operator can navigate inside Energy menu by pressing up and down keys.

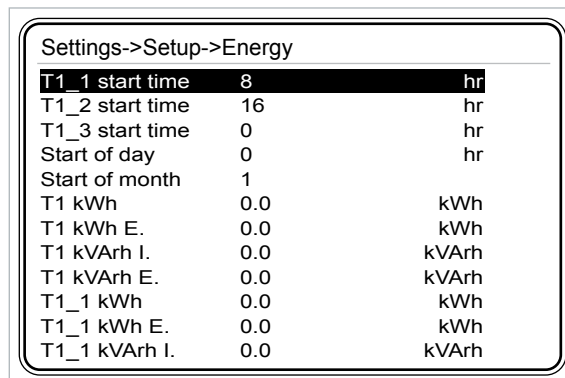

Figure 3-24 Energy Menu

3.2.1.1.3.1 T1_1 start time

Electric meters can have more than one tariff and also individual tariffs can be sliced in time.

'T1_1' abbreviation refers to the first time slice of tariff 1 meter. T1_1 start time can be adjusted between 0-23 (for Virtual Keyboard [Refer to 3.1.4 Example](#)).

"T1 rate1" meter (the first time slice of T1 meter - T1_1) counts between T1_1 start time and T1_2 start time.

Example:

Assume that 'T1_1 start time' and 'T1_2 start time' are adjusted as 8 and 16 respectively. "T1 rate1 meter (T1_1)" counts starting from 08:00 and ceases at 16:00.

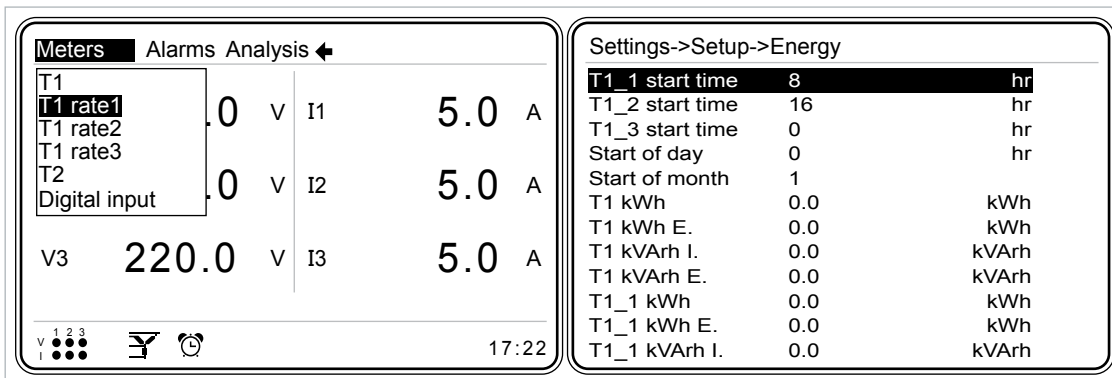

Figure 3-25 T1_1 start time

3.2.1.1.3.2 T1_2 start time

'T1_2' abbreviation refers to the second time slice of tariff 1 meter.

T1_2 start time can be adjusted between 0-23 (for Virtual Keyboard [Refer to 3.1.4 Example](#)).

"T1 rate2" meter (the second time slice of T1 meter - T1_2) counts between T1_2 start time and T1_3 start time.

Example:

Assume that 'T1_2 start time' and 'T1_3 start time' are adjusted as 16 and 0 respectively. "T1 rate 2 meter (T1_2)" counts starting from 16:00 and ceases at 00:00.

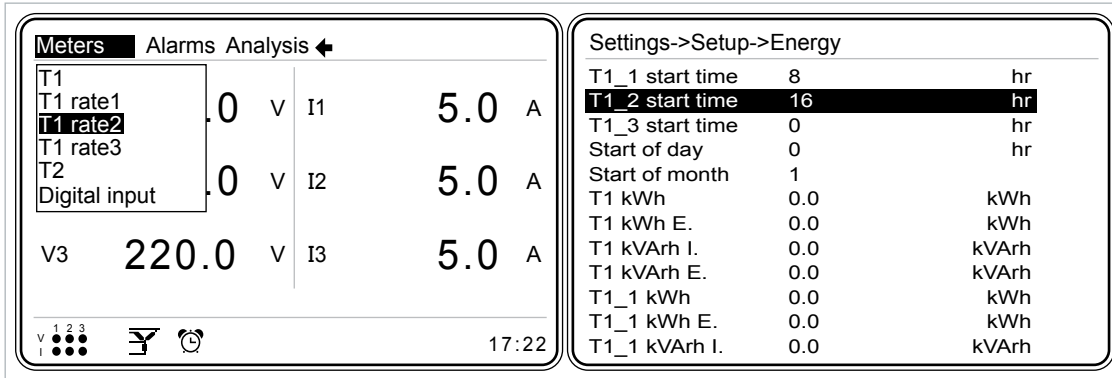

Figure 3-26 T1_2 start time

3.2.1.1.3.3 T1_3 start time

'T1_3' abbreviation refers to the third time slice of tariff 1 meter.

T1_3 start time can be adjusted between 0-23 (for Virtual Keyboard [Refer to 3.1.4 Example](#)).

"T1 rate3" meter (the second time slice of T1 meter - T1_3) counts between T1_3 start time and T1_1 start time.

Example:

Assume that 'T1_3 start time' and 'T1_1 start time' are adjusted as 0 and 8 respectively. "T1 rate 3 meter (T1_3)" counts starting from 16:00 and ceases at 00:00.

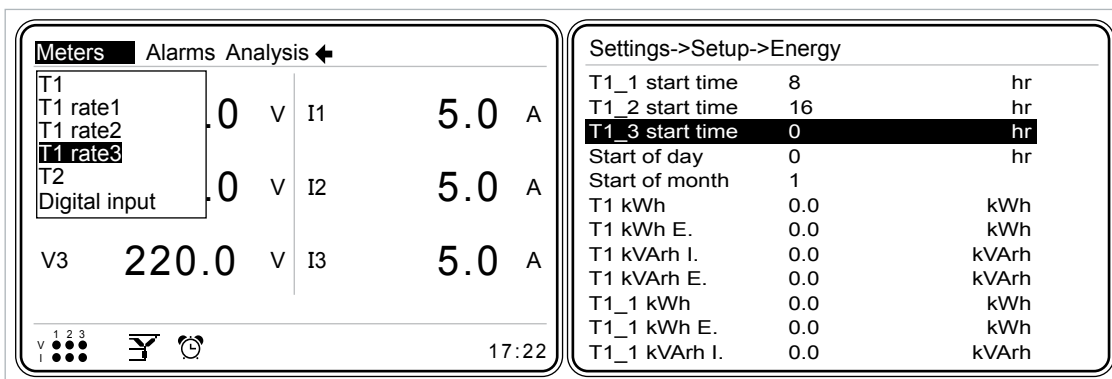

Figure 3-27 T1_3 start time



If T1_1 and T1_2 have the same value, T1_1 and T1_3 counters count; If T1_1 and T1_3 have the same value T1_1 and T1_2 counters count; if T1_2 and T1_3 have the same value; T1_1 and T1_2 counters count, If T1_1, T1_2 and T1_3 have the same value, only T1_1 counter will count.

3.2.1.1.3.4 Start of day

Start of day can be adjusted between 0 - 23. (for Virtual Keyboard [Refer to 3.1.4 Example](#))

3.2.1.1.3.5 Start of month

Start of month can be adjusted between 1 - 28. (for Virtual Keyboard [Refer to 3.1.4 Example](#))

The settings listed below (between 3.2.1.1.3.6 and 3.2.1.1.3.25) are used to synchronize the system electric meter and KLEA meter. Each of the below items can be adjusted between 0.000↔20000000000,0 (for Virtual Keyboard [Refer to 3.1.4 Example](#)).



Klea meters calculate energy by multiplying with CTR and VTR values. User should take this fact into account when entering the below initial energy values.

3.2.1.1.3.6 T1 kWh

"Initial" value for import active energy of T1 can be entered in this tab.

3.2.1.1.3.7 T1 kWh E.

"Initial" value for export active energy of T1 can be entered in this tab.

3.2.1.1.3.8 T1 kVArh I.

"Initial" value for import reactive energy of T1 can be entered in this tab.

3.2.1.1.3.9 T1 kVArh E.

"Initial" value for export reactive energy of T1 can be entered in this tab.

3.2.1.1.3.10 T1_1 kWh

"Initial" value for import active energy of T1_1 can be entered in this tab.

3.2.1.1.3.11 T1_1 kWh E.

"Initial" value for export active energy of T1_1 can be entered in this tab.

3.2.1.1.3.12 T1_1 kVArh I.

"Initial" value for import reactive energy of T1_1 can be entered in this tab.

3.2.1.1.3.13 T1_1 kVArh E.

"Initial" value for export reactive energy of T1_1 can be entered in this tab.

3.2.1.1.3.14 T1_2 kWh

"Initial" value for import active energy of T1_2 can be entered in this tab.

3.2.1.1.3.15 T1_2 kWh E.

"Initial" value for export active energy of T1_2 can be entered in this tab.

3.2.1.1.3.16 T1_2 kVArh I.

"Initial" value for import reactive energy of T1_2 can be entered in this tab.

3.2.1.1.3.17 T1_2 kVArh E.

"Initial" value for export reactive energy of T1_2 can be entered in this tab.

3.2.1.1.3.18 T1_3 kWh

"Initial" value for import active energy of T1_3 can be entered in this tab.

3.2.1.1.3.19 T1_3 kWh E.

"Initial" value for export active energy of T1_3 can be entered in this tab.

3.2.1.1.3.20 T1_3 kVArh I.

"Initial" value for import reactive energy of T1_3 can be entered in this tab.

3.2.1.1.3.21 T1_3 kVArh E.

"Initial" value for export reactive energy of T1_3 can be entered in this tab.

3.2.1.1.3.22 T2 kWh

"Initial" value for import active energy of T2 can be entered in this tab.

3.2.1.1.3.23 T2 kWh E.

"Initial" value for export active energy of T2 can be entered in this tab.

3.2.1.1.3.24 T2 kVArh I.

"Initial" value for import reactive energy of T2 can be entered in this tab.

3.2.1.1.3.25 T2 kVArh E.

“Initial” value for export reactive energy of T2 can be entered in this tab.

3.2.1.1.4 Digital Input Menu

Digital input menu consists of Input1 and Input2 menus. KLEA digital inputs are used in order to activate Tariff 2 meter and/or to count a digital signal.

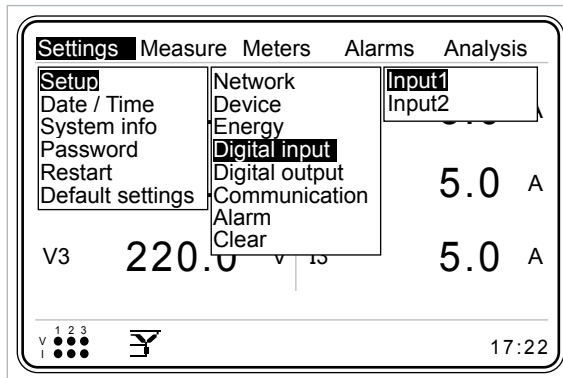

Figure 3-28 Digital Input Menu

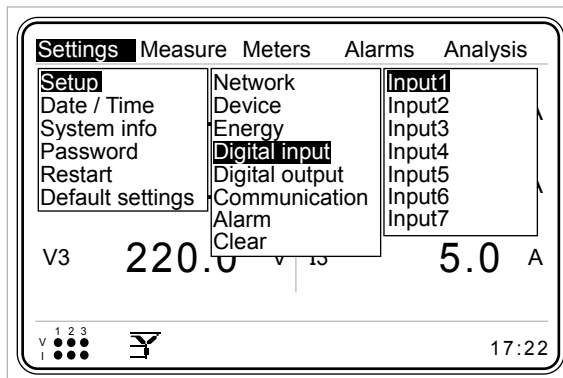

Figure 3-29 Digital Input Menu (With IO option)

3.2.1.1.4.1 Input1 Menu

Input1 operates when DI1 and GND pins of KLEA are short circuited. Input1 menu has two settings:

- Mode
- Delay

3.2.1.1.4.1.1 Mode

Mode options are as seen below (Figure 3-30). Press up and down keys to scroll inside options. Press OK key to select the desired option.

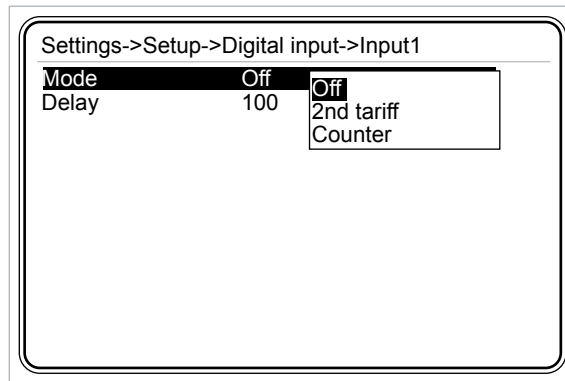

Figure 3-30 Mode Selection

- Assume that for digital input 1, '2nd tariff' is selected as the mode setting. Under this condition, when digital input 1 is short circuited (activated), tariff 1 meter will stop and tariff 2 meter will start to count.
- Assume that for digital input 1, 'Counter' is selected as the mode setting. Under this condition, each time DI1 and GND pins are short-circuited, "Meters->Digital input->Digital input1 counter" counts (Figure 3-31).

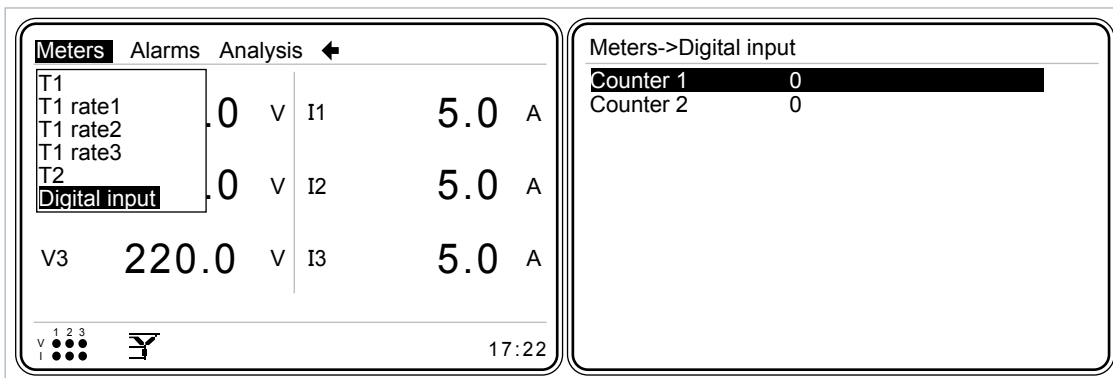

Figure 3-31 Digital Input1 Counter

3.2.1.1.4.1.2 Delay

Digital input delay can be adjusted between 10↔2000 milliseconds. In order for '2nd tariff' or 'Counter' modes to be activated; DI1 and GND pins should be short-circuited at least "delay" period of time. (for Virtual Keyboard Refer to 3.1.4 Example)

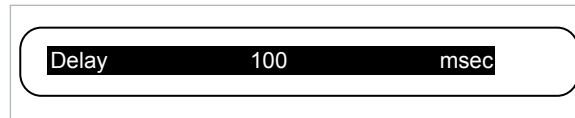

Figure 3-32 Delay

Example:

Digital input : Input1
Mode : Counter,
Delay : 200 msec

When DI1 and GND pins are short-circuited for minimum 200 msec, 'Input 1 Counter' increments by 1.

Example:

Digital input : Input1
Mode : Tariff 2
Delay : 200 msec

In order for the Tariff 2 meter to be active, DI1 and GND pins should be short-circuited for minimum 200 msec. Tariff 2 meter will be active during the course of short circuit time.

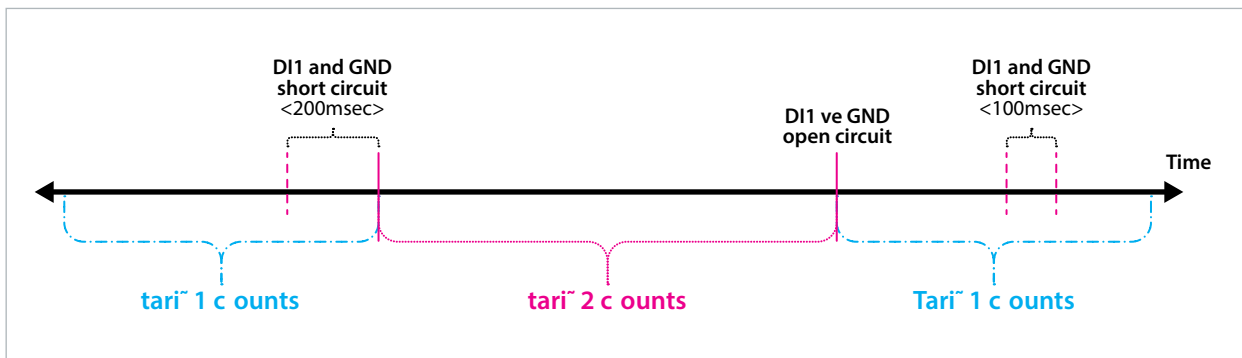

Figure 3-33 Tariff 1 or Tariff 2 Activation

3.2.1.1.4.2 Input 2 Menu

Input 2 applications and settings are the same as Input1. Digital input2 operates with DI2 and GND pins.

3.2.1.1.4.3 Input 3 Menu (optional)

Input 3 is applicable to optional digital IO Klea models. Input 3 applications and settings are the same as Input1. Digital input3 operates with DI3 and GND pins.

3.2.1.1.4.4 Input 4 Menu (optional)

Input 4 is applicable to optional digital IO Klea models. Input 4 applications and settings are the same as Input1. Digital input4 operates with DI4 and GND pins.

3.2.1.1.4.5 Input 5 Menu (optional)

Input 5 is applicable to optional digital IO Klea models. Input 5 applications and settings are the same as Input1. Digital input5 operates with DI5 and GND pins.

3.2.1.1.4.6 Input 6 Menu (optional)

Input 6 is applicable to optional digital IO Klea models. Input 6 applications and settings are the same as Input1. Digital input6 operates with DI6 and GND pins.

3.2.1.1.4.7 Input 7 Menu (optional)

Input 7 is applicable to optional digital IO Klea models. Input 7 applications and settings are the same as Input1. Digital input7 operates with DI7 and GND pins.

3.2.1.1.5 Digital Output Menu

It comprises of Output1 and Output2 menus.

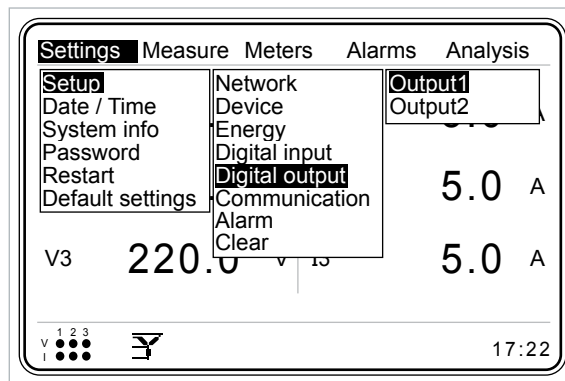

Figure 3-34 Digital Output Menu

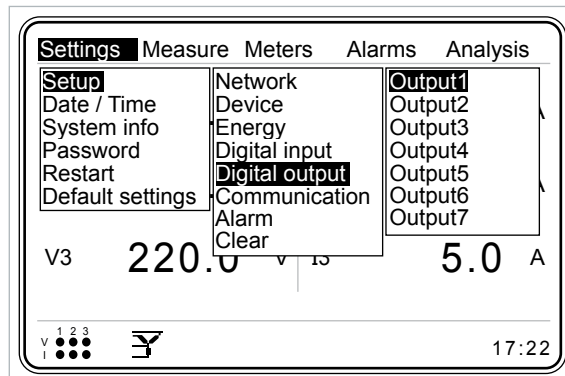

Figure 3-35 Digital Output Menu (optional digital I/O model)

3.2.1.1.5.1 Output1 Menu

Output1 gives output from D01- and D01+ pins.

Mode: Press up and down keys to navigate between digital outputs. Press OK on the desired output, and options seen in Figure 3-36 will appear. Any of them can be assigned as output1 operating mode.

Mode setting has the following options.

- Off
- T1 kWh
- T1 kWh E.
- T1 kVArh I.
- T1 kVArh E.
- T1_1 kWh
- T1_1 kWh E.
- T1_1 kVArh I.
- T1_1 kVArh E.
- T1_2 kWh
- T1_2 kWh E.
- T1_2 kVArh I.
- T1_2 kVArh E.
- T1_3 kWh
- T1_3 kWh E.
- T1_3 kVArh I.
- T1_3 kVArh E.
- T2 kWh
- T2 kWh E.
- T2 kVArh I.
- T2 kVArh E.
- Digital Input

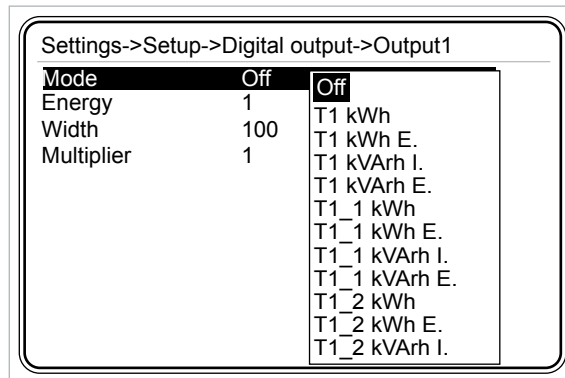

Figure 3-36 Output1 Menu

**Energy:**

When selected meter option(mode option) counts for the selected “energy” value, Output1 generates a pulse (for Virtual Keyboard [Refer to 3.1.4 Example](#)).

Width:

It can be adjusted between 50 – 2500 msec (for Virtual Keyboard [Refer to 3.1.4 Example](#)).

Multiplier:

Multiplier is of use only when “Output1->mode” is adjusted as “Digital input”.

When “digital input1 counter” ([Refer to Digital input 3.2.3.6](#)) reaches the ‘multiplier’; “digital output1” generates a pulse from DO1+ and DO1- pins.

It can be adjusted between 1 - 10000 (for Virtual Keyboard [Refer to 3.1.4 Example](#)).

Second example explains this implementation.

Example:

Assume the settings are as below,

Digital output : Output1
Mode : T1 kWh
Energy : 2
Width : 100msec

Assume that, Tariff 1 import active previous value is 1.1kWh. When T1 kWh reaches to 3.1kWh, 5.1kWh, 7.1kWh etc. a pulse of 100msec will be generated at the outputs of DO1- and DO1+.

Example:

Digital output : Output1
Mode : Digital input
Energy : When connection type is digital input, the Energy tab is not used.
Width : 100msec
Multiplier : 100

Assume also that Digital input1 mode had been adjusted as “counter”. In this case, when Counter1 reaches 100 or multiples of 100, a pulse of 100 msec will be will be generated at the output pins DO1- and D01+.

Assume that the digital input 1 counter value was 35 before multiplier adjustment. Assume also that operator adjusts ‘Multiplier’ as 100. Under these conditions, Output 1 generates a pulse when digital input 1 counter reaches the values 135, 235, 335, 435 and so on.

Operator can adjust KLEA to give output from analog output channels for the following parameters: voltage, current, active power, reactive power, apparent power, frequency, phase-phase voltages, neutral current, total current, total active power, total reactive power and total apparent power pertaining to L1, L2, L3 phases.

Analog output channels can be adjusted to generate signals as 0-5V, 0-10V, -5-5V, -10-10V, 0-20mA, 4-20mA. Analog output menu comprises of the following submenus.

Output1 (available in 2 analog and 4 analog outputs models)

Output2 (available in 2 analog and 4 analog outputs models)

Output3 (available only in 4 analog outputs model)

Output4 (available only in 4 analog outputs model)

3.2.1.1.6.1 Output1 Menu

Output1 menu comprises of the following submenus.

- Input mode
- Output conn.
- Min. Value
- Max. Value
- Multiplier

Settings->Setup->Analog output->Output1	
Input mode	V1 (L-N)
Output conn.	0-5V
Min. value	0.0
Max. value	0.0
Multiplier	1

Figure 3-38 Output1

3.2.1.1.6.1.1 Input mode

Analog output will generate a signal in accordance with the parameter selected in Input mode tab. Analog output examples will clarify the application of settings.

Input mode options are as follows:

- V1(L-N)
- V2(L-N)
- V3(L-N)
- I1
- I2
- I3
- P1
- P2
- P3
- Q1
- Q2
- Q3
- S1
- S2
- S3
- F
- IN
- VLL12
- VLL23
- VLL31
- I tot.
- P tot.
- Q tot.
- S tot.

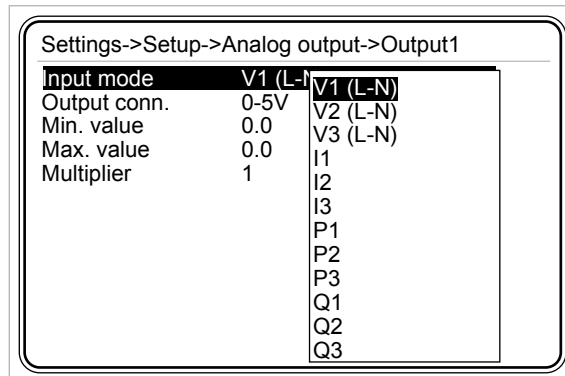

Figure 3-39 Input mode

3.2.1.1.6.1.2 Output connection

Inside Output1 menu, press up and down keys to select (highlight) 'Output connection' menu item. When 'Output connection' is selected, press OK key and the options in Figure 3-40 will appear on the screen. Press up and down keys to select the desired option and press OK key to complete the setting.

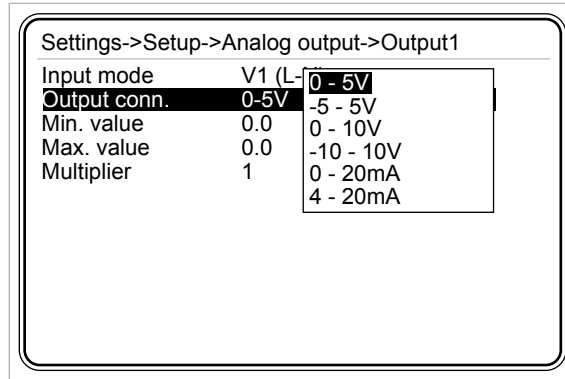

Figure 3-40 Output connection

Assume that for analog output 1, output connection was selected as 0-5V (refer to Figure 3.40). Then, operator should adjust the "analog output 1" dip switch as seen in Figure 3-41 (Vout1 -> ON ; Iout1 -> OFF). After the dip switch adjustment, setting will be completed.

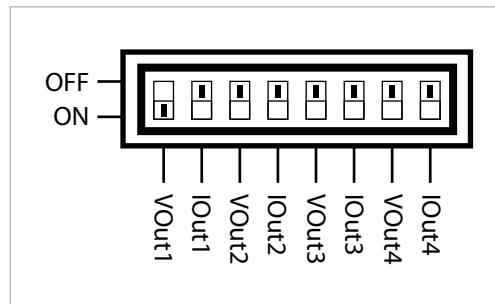

Figure 3-41 Vout1 -> ON ; Iout1 -> OFF

Assume that for analog output 1, output connection was selected as 4-20 mA (refer to Figure 3.40). Then, operator should adjust the "analog output 1" dip switch as seen in Figure 3-42 (Vout1 -> OFF; Iout1 -> ON). After the dip switch adjustment, setting will be completed.

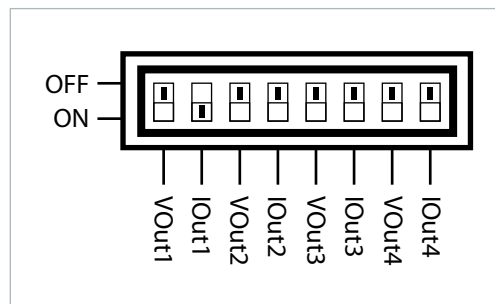

Figure 3-42 Vout1 -> OFF; Iout1 -> ON



In order to obtain voltage output, Vout1 should be set to ON, and Iout1 should be set to OFF. If both switches are ON or OFF at the same time, analog output will not operate correctly.



In order to obtain current output, Vout1 should be set to OFF, and Iout1 should be set to ON. If both switches are ON or OFF at the same time, analog output will not operate correctly.



If the setting of output connection and setting of the dip switch are incompatible, related analog output will not operate correctly.

3.2.1.1.6.1.3 Min. value

The minimum value for the selected input mode. See also 3.2.1.1.6.1.5 Multiplier setting.

3.2.1.1.6.1.4 Max. value

The maximum value for the selected input mode. See also 3.2.1.1.6.1.5 Multiplier setting.



If "Min. value" and "Max. value" are adjusted to be the same, then analog output will not operate.

3.2.1.1.6.1.5 Multiplier

When 'Multiplier' is selected, press OK key and the options in Figure 3-43 will appear on the screen. Press up and down keys to select the desired option and press OK key to complete the setting. Multiplier coefficient options are as follows:

- 1
- Kilo (1000)
- Mega (1000000)

For example, assume that 10000000W and 350000000W are required to be entered for min. and max. values. In this case, if operator selected Mega in multiplier tab, then it will be sufficient to enter 10 and 350 for min. and max. values.

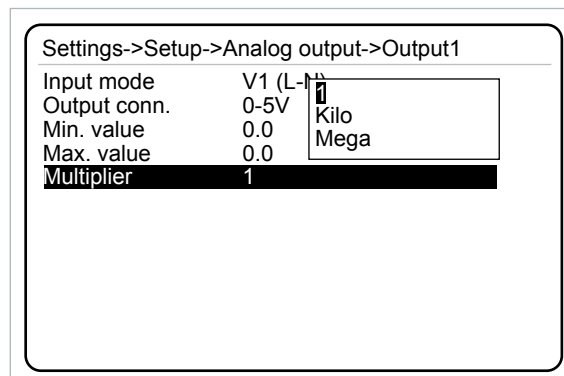

Figure 3-43 Multiplier

Klea can output 0 – 5V, -5 – 5V, 0 – 10V, -10 – 10V, 0 – 20mA and 0 – 20mA range signals from AOX-GND pins.

When the value of 'Input mode' parameter falls below 'Min. value' with an amplitude less than 2.5%; or exceeds 'Max. value' with an amplitude again less than 2.5%; output signal will linearly follow this change. For 'Output conn.' types whose low limit is zero, output signal will not fall below zero; only high limit will change linearly up to 2.5% of its value.

In summary, output signals from AOX-GND pins will operate as follows:

0 – 5 V	→	0 – 5.125 V	(output signal low value will not fall below zero)
-5 – 5 V	→	-5.125 – 5.125 V	
0 – 10 V	→	0 – 10.25 V	(output signal low value will not fall below zero)
-10 – 10 V	→	-10.25 – 10.25 V	
0 – 20 mA	→	0 – 20.5 mA	(output signal low value will not fall below zero)
4 – 20mA	→	3.9 – 20.5 mA	

When the value of 'Input mode' parameter falls below 'Min. value' with an amplitude more than 2.5%; or exceeds 'Max. value' with an amplitude again more than 2.5%; output signal will change. In this case, output signals from AOX-GND pins will operate as follows in order to indicate that there is a problem in the electrical network:

for 0 – 5 V setting; AOX-GND signal amplitude will be	10 V
for -5 – 5V setting; AOX-GND signal amplitude will be	10 V
for 0 – 10 V setting; AOX-GND signal amplitude will be	10.8 V
for -10 – 10 V setting; AOX-GND signal amplitude will be	10.8 V
for 0 – 20 mA setting; AOX-GND signal amplitude will be	21.6 mA
for 4 – 20 mA setting; AOX-GND signal amplitude will be	21.6 mA

The amplitude of analog output signal on AO1-GND pins will be as calculated by the following formula.

$$AO1-GND = \left[\frac{AO1 \text{ con.highlimit} - AO1 \text{ con.lowlimit}}{(\text{Max value} - \text{Min value}) \times \text{Multip.}} \times (\text{Meas. value} - (\text{Min value} \times \text{Multip.})) \right] + AO1 \text{ con. low limit}$$

Example1:

Assume that the following values have been assigned;

- Input connection : V1(L-N) (phase-neutral voltage of phase 1)
- Output connection: 0-5V
- Min. value : 100V
- Max. value : 200V
- Multiplier : 1

Then, when measure is KLEA V1(L-N)=120V, the result will be as follows,



$$AO1-GND = \left[\frac{5-0}{(200-100) \times 1} \times (120 - (100 \times 1)) \right] + 0 = 1V$$

When measure is KLEA V1(L-N)=185V, the result will be as follows,

$$AO1-GND = \left[\frac{5-0}{(200-100) \times 1} \times 1 \times (185 - (100 \times 1)) \right] + 0 = 4.25V$$

Example2:

Assume that the following have been assigned;

Input connection : P tot.(total active power)

Output connection: 4-20mA

Min. value : 600W

Max. value : 1000W

Multiplier : 1

Then, when measure is KLEA P tot. = 732W, the result will be as follows,

$$AO1-GND = \left[\frac{20-4}{(1000-600) \times 1} \times (732 - (600 \times 1)) \right] + 4 = 5.28mA$$

When measure is KLEA V1(L-N)=992W, the result will be as follows,

$$AO1-GND = \left[\frac{20-4}{(200-100) \times 1} \times (992 - (600 \times 1)) \right] + 4 = 19.68mA$$

Example3:

Assume that the following have been assigned;

Input connection : Q tot.(total reactive power)

Output connection: -10 - 10V

Min. value :1400VAR

Max. value :1800VAR,

Multiplier : kilo

When measure is KLEA S tot.=1485000VAR, the result will be as follows,

$$AO1-GND = \left[\frac{10-(-10)}{(1800-1400) \times 1000} \times (1485000 - (1400 \times 1000)) \right] + (-10) = -5.75V$$

When measure is KLEA V1(L-N)=1695000VA , the result will be as follows,

$$AO1-GND = \left[\frac{10-(-10)}{(1800-1400) \times 1000} \times (1695000 - (1400 \times 1000)) \right] + (-10) = 4,75V$$

3.2.1.1.6.2 Output2 Menu

Analog output 2 settings are the same as Output1. Analog output2 gives output from AO2- GND pins.

3.2.1.1.6.3 Output3 Menu

Analog output 3 settings are the same as Output1. Analog output2 gives output from AO3- GND pins.

3.2.1.1.6.4 Output4 Menu

Analog output 4 settings are the same as Output1. Analog output2 gives output from AO4- GND pins.

3.2.1.1.7 Communication Menu

KLEA implements MODBUS over serial line with RTU mode. In this menu, settings related with Modbus RTU are accomplished.

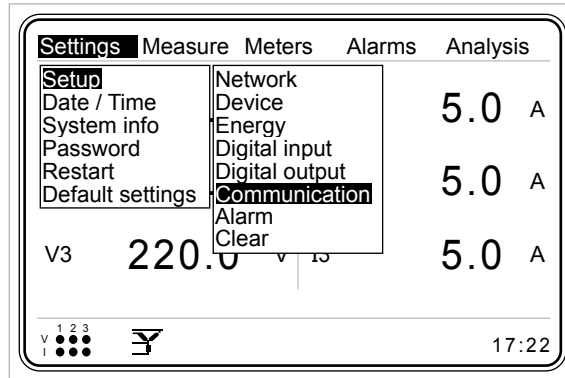

Figure 3-44 Communication Menu

3.2.1.1.7.1 Baud Rate Menu

Inside Communication menu, press up and down keys to select (highlight) 'Baud rate' menu item. Press OK key and baud rate options will appear on the screen as seen in Figure 3-45. Scroll inside options by pressing up and down keys; press OK key to select the desired value. Available baud rates are: 2400, 4800, 9600, 19200, 38400, 57600 and 115200 bit/sec.

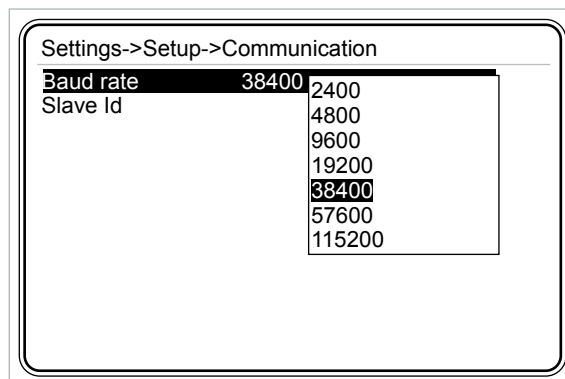

Figure 3-45 Setting Baud Rate

3.2.1.1.7.2 Slave Id

In this tab, operator can adjust the slave ID. (For Virtual Keyboard [Refer to 3.1.4 Example](#)).

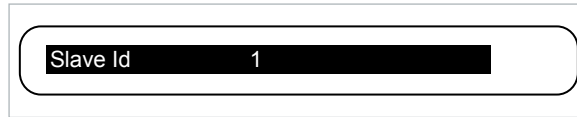

Figure 3-46 Slave Id

KLEA can operate in an RS-485 network having a maximum quantity of 247 units. As a result, 'Slave Id' can be adjusted between 1 and 247.

3.2.1.1.8 Alarm Menu

Inside 'Setup' menu, when 'Alarm' is selected, press OK key and the options in Figure 3-47 will appear on the screen. Press up and down keys to select the desired option and press OK key to complete the setting.

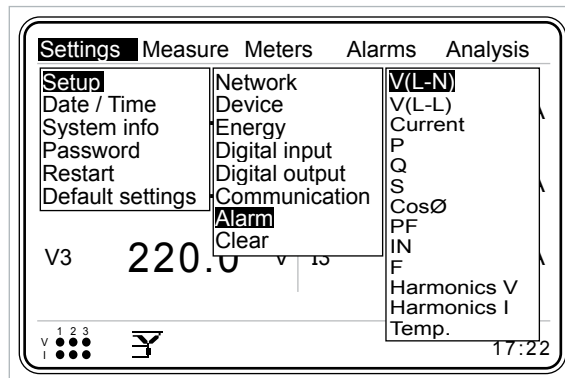

Figure 3-47 Alarm Menu

3.2.1.1.8.1 V(L-N) Menu

Inside 'Alarm' menu, when V(L-N) is highlighted, press OK key and the following page will appear on the screen.

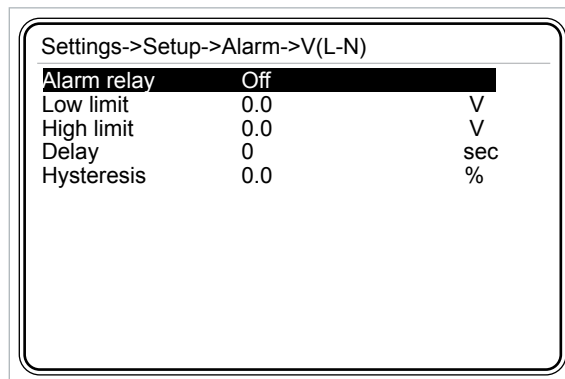

Figure 3-48 V(L-N) Menu

Alarm relay:

This setting is merely used to energize or not to energize a relay, when an alarm occurs. For alarm relay setting, following options are available:

- Off : In case of V(L-N) alarm, none of the alarm relays is energized
- Relay1 : In case of V(L-N) alarm, relay 1 is energized
- Relay2 : In case of V(L-N) alarm, relay 2 is energized

Press up and down keys to select the desired option and press OK key to complete the setting.

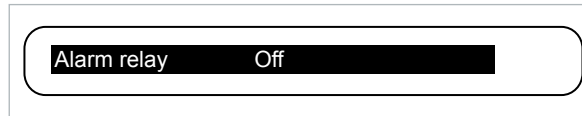

Figure 3-49 Alarm Relay Setup

In order to adjust Klea to issue V (L-N) alarms, operator should adjust low limit and high limit values as described below.

When V(L-N) of “any” of the three phases exceeds “Low limit” or “High Limit”, Klea gives an alarm.

Low Limit:

Low limit value for the V(L-N) alarm. (For Virtual Keyboard [Refer to 3.1.4 Example](#)). In order to set an alarm for V(L-N), operator should enter a low limit value smaller than the high limit value. When low limit and high limit values are entered to be the same, V(L-N) alarm will be deactivated (no alarm will be set).

High Limit:

High limit value for the V(L-N) alarm. (For Virtual Keyboard [Refer to 3.1.4 Example](#)). In order to set an alarm for V(L-N), operator should enter a high limit value larger than the low limit value. When low limit and high limit values are entered to be the same, V(L-N) alarm will be deactivated (no alarm will be set).

Delay:

When the related alarm parameter exceeds the “Low limit” or “High Limit” value; before declaring an alarm, Klea waits for “delay time”. Similarly, when the related alarm parameter enters into the limit values, Klea waits for “delay time”, before cancelling the alarm. “Delay” can be adjusted between 0↔600 sec. (For Virtual Keyboard [Refer to 3.1.4 Example](#)).

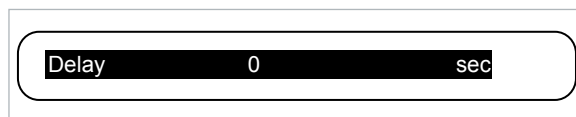

Figure 3-50 Alarm Time Setting

Hysteresis:

It is the tolerance entered as percentage for high and low limits . Hysteresis can be adjusted between 0↔20. (For Virtual Keyboard [Refer to 3.1.4 Example](#)). Examine following example and Figure 3-52.

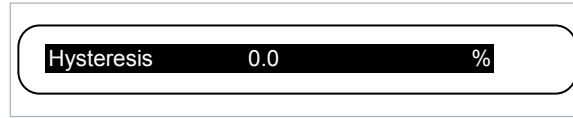

Figure 3-51 Hysteresis Setting

Example:

For the following figure('Delay' is adjusted to be zero);

At point A, alarm occurs

At point B, alarm disappears

At point C, alarm occurs

At point D, alarm disappears

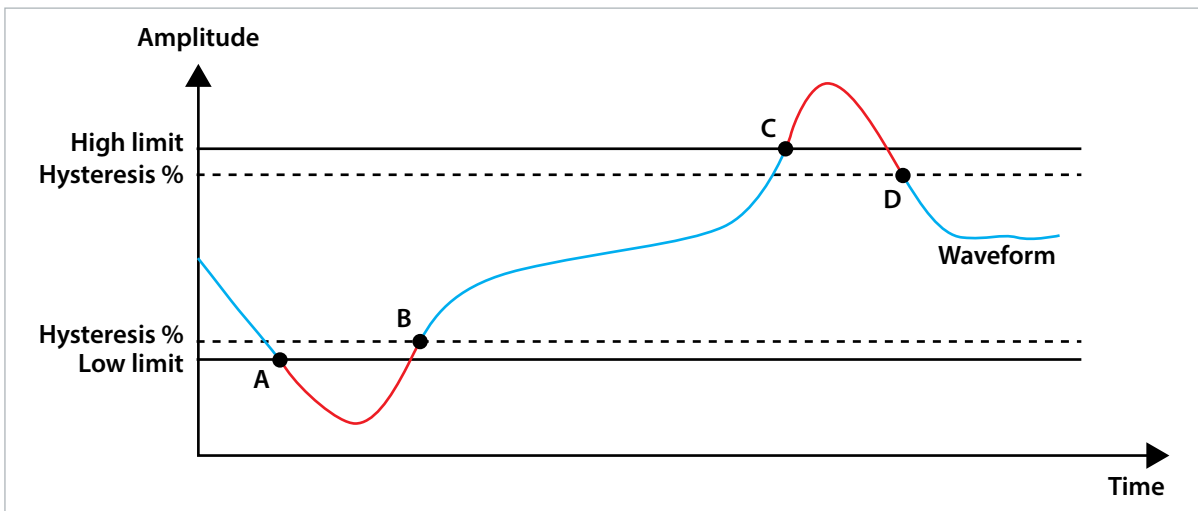

Figure 3-52 Alarm Example

3.2.1.1.8.2 V(L-L) Menu

Alarm for phase-to-phase voltages is adjusted in this submenu. V(L-L) settings are the same as V(L-N). Low and high limit values can be adjusted between 0↔2600000.

3.2.1.1.8.3 Current Menu

Alarm for current is adjusted in this submenu. Current settings are the same as V(L-N). Low and high limit values can be adjusted between 0↔30000.

3.2.1.1.8.4 P Menu

Alarm for active power is adjusted in this submenu. P settings are the same as V(L-N). Low and high limit values can be adjusted between -10000000000↔10000000000.

3.2.1.1.8.5 Q Menu

Alarm for reactive power is adjusted in this submenu. Q settings are the same as V(L-N). Low and high limit values can be adjusted between -10000000000↔10000000000.

3.2.1.1.8.6 S Menu

Alarm for apparent power is adjusted in this submenu. S settings are the same as V(L-N). Low and high limit values can be adjusted between 0.0↔10000000000.

3.2.1.1.8.7 CosØ Menu

Alarm for cosØ is adjusted in this submenu. cosØ settings are the same as V(L-N). Low and high limit values can be adjusted between 0↔1.

3.2.1.1.8.8 PF Menu

Alarm for power factor is adjusted in this submenu. Power factor settings are the same as V(L-N). Low and high limit values can be adjusted between 0↔1.

3.2.1.1.8.9 IN Menu

Alarm for neutral current is adjusted in this submenu. Neutral current settings are the same as V(L-N). Low and high limit values can be adjusted between 0↔90000.

3.2.1.1.8.10 F Menu

Alarm for frequency is adjusted in this submenu. Frequency settings are the same as V(L-N). Low and high limit values can be adjusted between 35↔70.

3.2.1.1.8.11 Temp. Menu

Alarm for temperature is adjusted in this submenu. Temperature settings are the same as V(L-N). Low and high limit values can be adjusted between -20↔80.



When the low and high limit values are entered the same, KLEA will not issue an alarm.

Settings->Setup->Alarm->Current		
Alarm relay	Relay1	
Low limit	0.0	A
High limit	0.0	A
Delay	0.0	sec
Hysteresis	0.0	%

Figure 3-53 Setting for No Alarm



When operator enters a low limit value larger than the high limit, "Invalid limits. Please check." message appears on the screen.

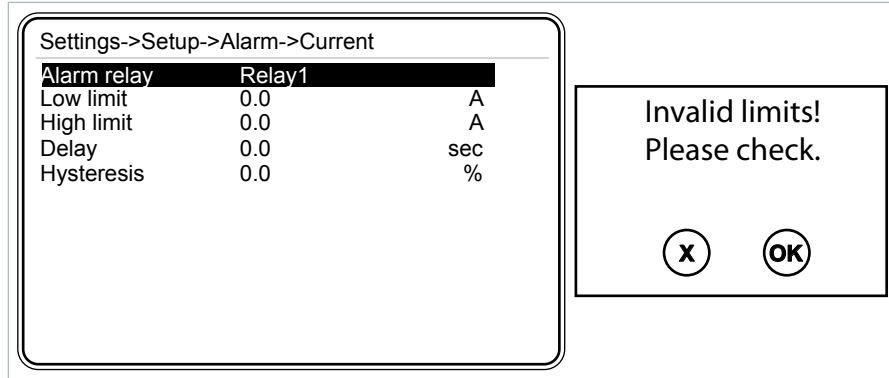

Figure 3-54 Invalid Limits message

3.2.1.1.8.12 Harmonics V Menu

Inside 'Alarm' menu, when Harmonics V is highlighted, press OK key and the following page will appear on the screen.

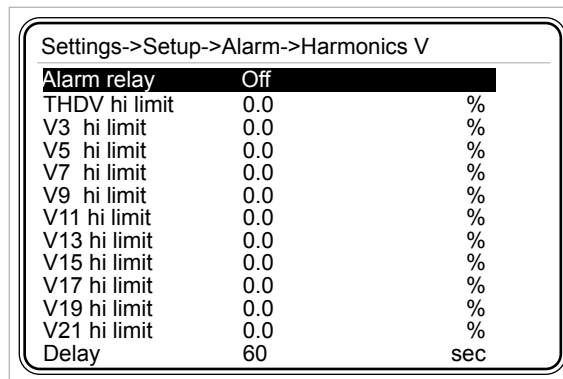

Figure 3-55 Harmonics Menu

Alarm relay: Refer to 3.2.1.1.8.1 V(L-N) Menu - Alarm relay setting.

THDV High Limit: High limit value for total harmonic distortion - voltage alarm (For Virtual Keyboard Refer to 3.1.4 Example). In order to set an alarm for THDV, operator should enter a high limit value larger than zero. When high limit is entered as zero, THDV alarm will be deactivated (no alarm will be set). It can be adjusted between 0↔100.

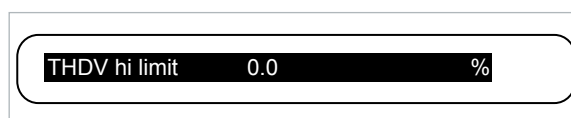

Figure 3-56 THDV High Limit Setting

V3 --- V21 high limit: "3.", "5." ... "21." harmonic distortion high limit values are entered. In order to set an alarm for V3, V5 – V21 operator should enter a high limit value larger than zero. When high limit is entered as zero (0.0), V3, V5 – V21 alarm(s) will be deactivated (no alarm will be set). High limits can be adjusted between 0↔100. (For Virtual Keyboard Refer to 3.1.4 Example)

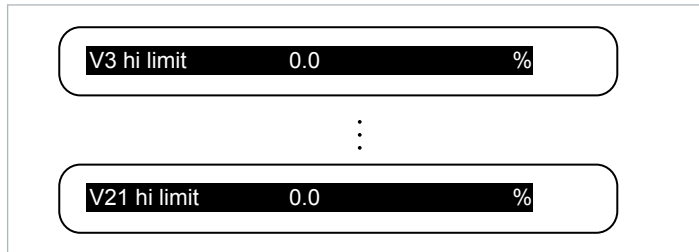

Figure 3-57 V3 - V21 Harmonic High Limit

Delay: See 3.2.1.1.8.1 V(L-N) Menu - Delay setting.

3.2.1.1.8.13 Harmonics I Menu

"Harmonics I" settings are the same as the "Harmonics V" alarm settings.

3.2.1.1.9 Clear Menu

In this tab, operator can clear demand values, energy (tariff meter) values and DI (Digital Input) counters. "All" option clears all, namely, demand, energy and DI counter values. When "Clear" is highlighted, press OK key and the following page will appear on the screen.

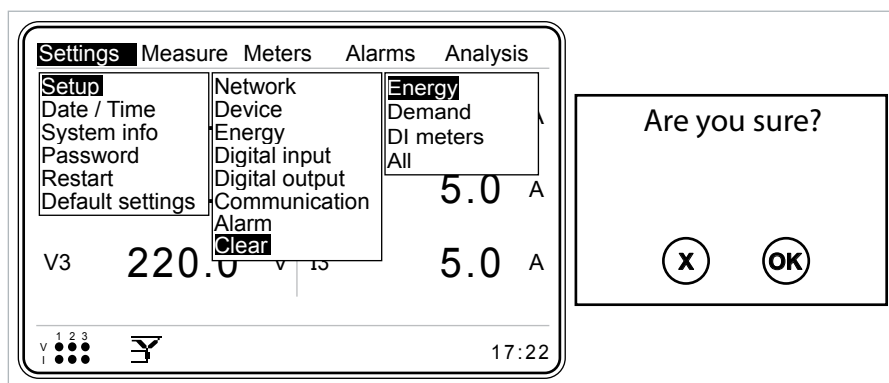

Figure 3-58 Clear Menu

Scroll inside options by pressing up and down keys; press OK key to clear the desired option. When OK key is pressed, "Are you sure?" message will appear on the screen. Press again OK key to clear the parameter; press X key to exit with no change in the selected parameter.

Assume that, "Meters->Tariff1->Imp. Active" (Import active power) submenu is as shown below

Meters->T1->Imp. active		
Index	267500.1	kWh
Curr. hour	0.5	kWh
Prev. hour	0.6	kWh
Curr. day	21.3	kWh
Prev. day	22.6	kWh
Curr. month	598.4	kWh
Prev. month	439.5	kWh

Figure 3-59 Before Clear

When the clear process is completed, the submenu “Meters->T1->Imp. Active” will be as shown in the Figure 3-60.

Meters->T1->Imp. active		
Index	0.0	kWh
Curr. hour	0.0	kWh
Prev. hour	0.0	kWh
Curr. day	0.0	kWh
Prev. day	0.0	kWh
Curr. month	0.0	kWh
Prev. month	0.0	kWh

Figure 3-60 After Clear

After the clear process, for index parameters, a value different than zero may be observed. This value, is the initial value entered by the operator.

Assume that, initial value of “Setup->Energy->T1 kWh” was entered as 2000 kWh. In this case, after the clear process is completed, “Meters->Tariff 1->Imp. Active” value will be 2000kWh. (See Figure 3.61).

Meters->T1->Imp. active		
Index	2000.0	kWh
Curr. hour	0.0	kWh
Prev. hour	0.0	kWh
Curr. day	0.0	kWh
Prev. day	0.0	kWh
Curr. month	0.0	kWh
Prev. month	0.0	kWh

Figure 3-61 Initial Value, After Clear Process

3.2.1.2 Date / Time Menu

In the following menu Date / Time setting is made (For date/time setting [Refer to 3.1.2 Example](#)).

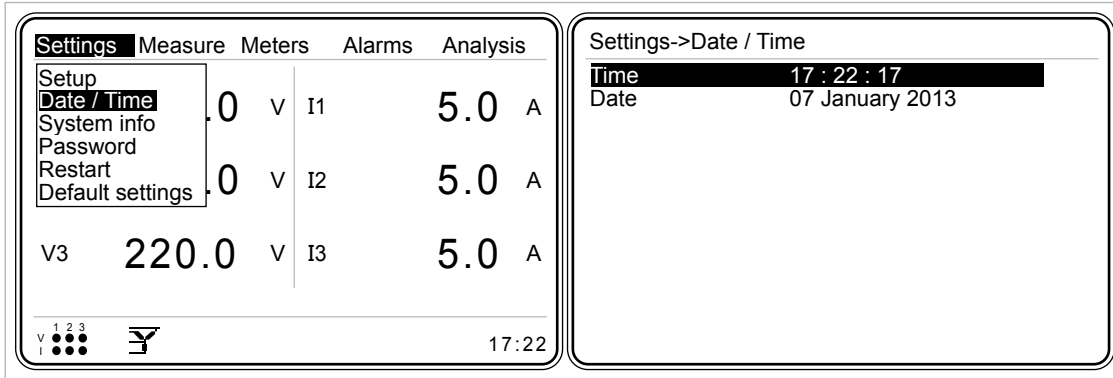

Figure 3-62 Date / Time Menu

3.2.1.3 System Info Menu

This menu is for information – no setting is accomplished.

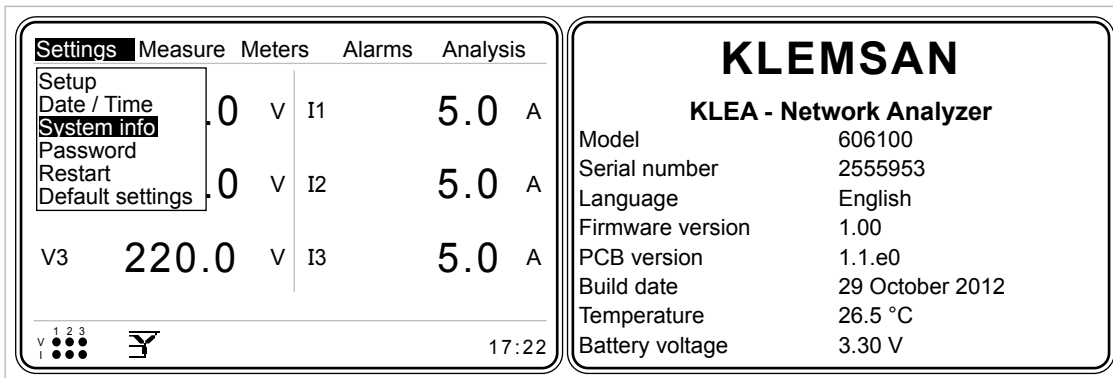

Figure 3-63 System Info

Temperature and battery voltage values can be reached via RS485.

3.2.1.4 Password Menu

If operator have not entered password; only Date/Time, System Info and Password tabs are active inside settings menu. In order for the remaining tabs to be activated, operator should login via 'Password' tab.

If the entered password is correct, "Login success" message appears on the screen. Otherwise, "Password mismatch" message will be displayed on the screen. (For Virtual Keyboard [Refer to 3.1.4 Example](#)).

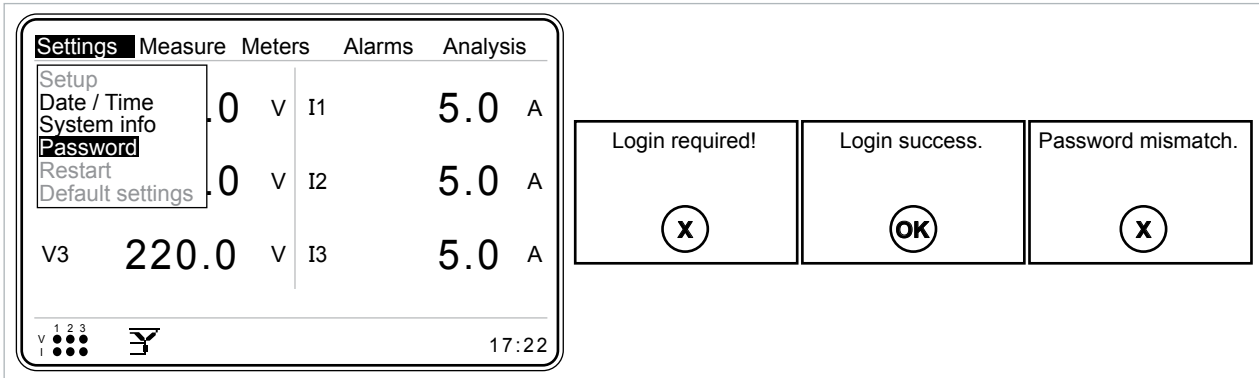

Figure 3-64 Password

3.2.1.5 Restart Menu

If OK key is pressed on the restart tab, "Are you sure?" message appears on the screen. Press again OK key to restart Klea.

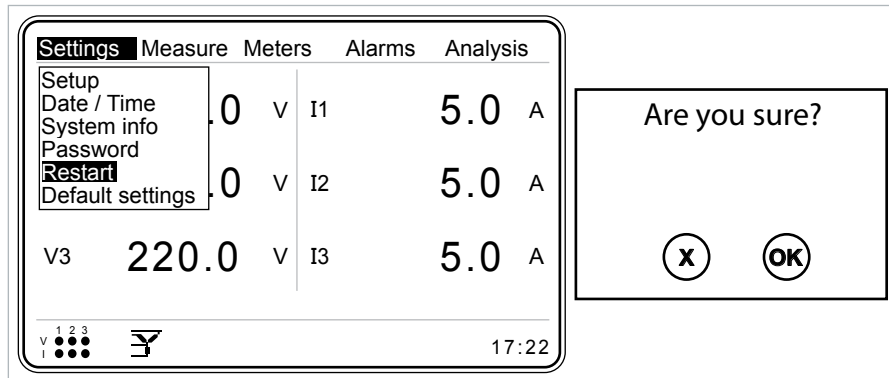

Figure 3-65 Restart

3.2.1.6 Default Settings

This menu is used to return to factory default settings. All settings except date and time return to the factory defaults.

Note: Tariff meter indexes are not assumed to be a setting. As a result, index values will not be cleared via this menu.

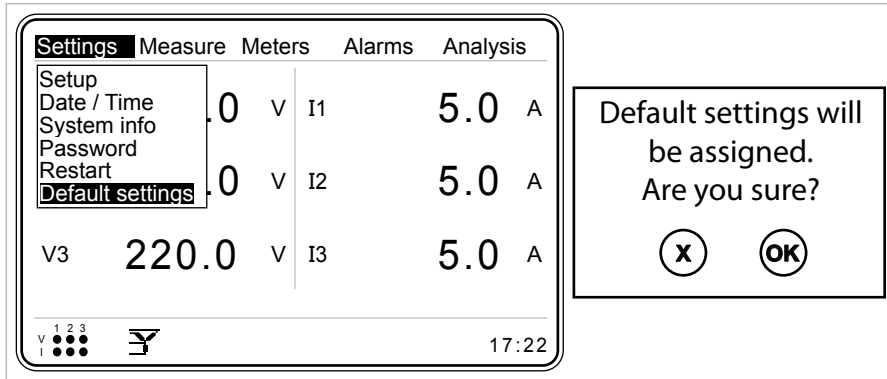

Figure 3-66 Default Settings Command

3.2.2 Measure Menu

The following submenus are included under the measure menu. Operator can navigate inside measure menu by up and down keys. When the desired menu item is highlighted, press OK key to select. Following menu items are available:

- Instantaneous
- Demand
- Phasor diagram
- Signals
- Harmonics

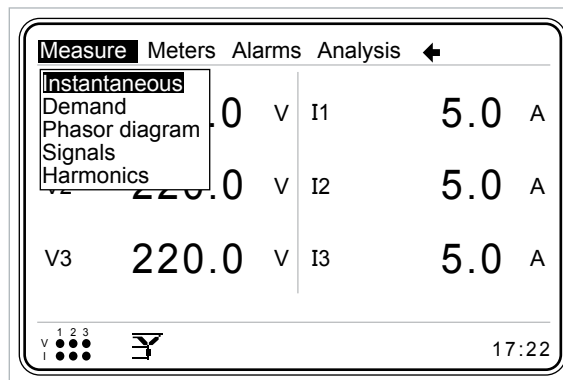

Figure 3-67 Measure Menu

3.2.2.1 Instantaneous Menu

This menu includes instantaneous values. If OK is pressed on this tab, the following page appears on the screen. Operator can scroll inside Instantaneous values by pressing right and left keys.

Measure->Instantaneous->V L-N		
V1	220.0	V
V2	220.0	V
V3	220.0	V
V0	220.0	V
← Powers V L-N V L-L →		

Figure 3-68 Instantaneous Menu

- Line-to-neutral V (L-N) voltage for each phase and their average
- Line-to-line V(L-L) voltage for each phase and their average
- Phase currents (I) and their sum
- Neutral current (IN)
- CosØ for each phase and CosØ of system
- Power factor (PF) for each phase and power factor (PF) of system
- Active power (P) for each phase and their sum
- Reactive power (Q) for each phase and their sum
- Apparent power (S) for each phase and their sum
- Frequency (F) for each phase
- THDV values for each phase and their sum
- THDI values for each phase and their sum
- Total powers



If "3phase 3 wire" is selected as connection type, "VL-N" title in instantaneous menu will be replaced with "V".

In Measure-Instantaneous-P(active power) page;

if active power value(of any phase) is positive (a "+" sign after the number), that phase consumes power,

if active power value(of any phase) is negative (a "-" sign after the number), that phase generates power.

The above phenomenon also applies for total P (active power) value.



When Klea is mounted on a panel which consumes power, the values in Measure-Instantaneous-P page should be positive(+). When Klea is mounted on a panel which generates power, the values in Measure-Instantaneous-P page should be negative(-).

Otherwise, K-L leads of the current should be cross connected.

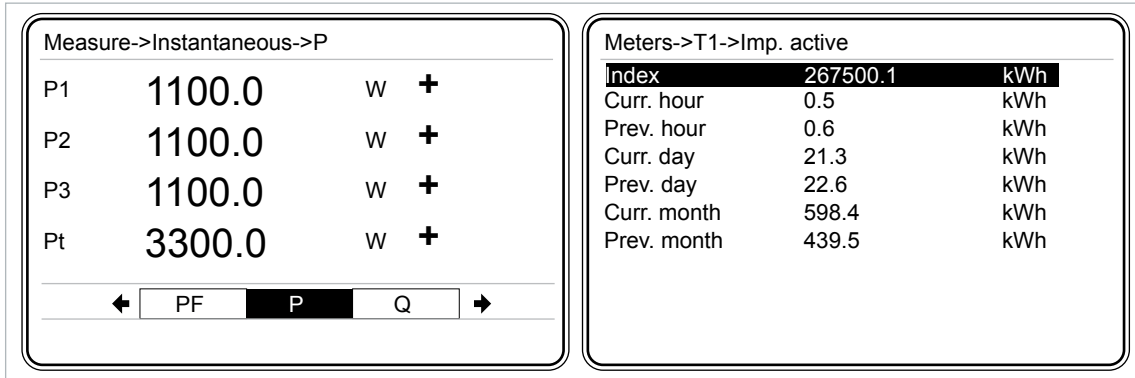

Figure 3-69 Connecting the K-L ends of Current Correctly

3.2.2.2 Demand Menu

During demand period, Klea, calculates averages for current, active, reactive and apparent powers for three phases. Maximum of these averages are stored as the demand value with a corresponding time stamp.

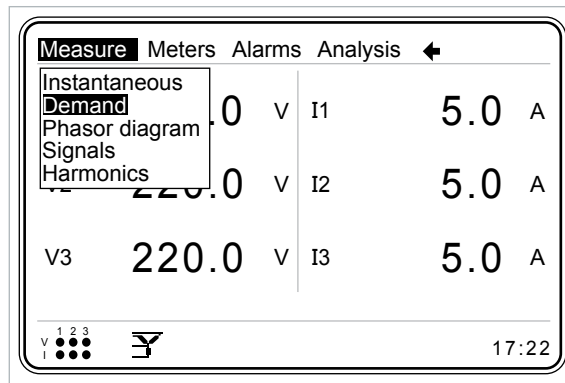

Figure 3-70 Demand Menu

Example:

The following graph shows the averages of current signals that are calculated/measured during the 15 minutes (demand period=15) and demand value.

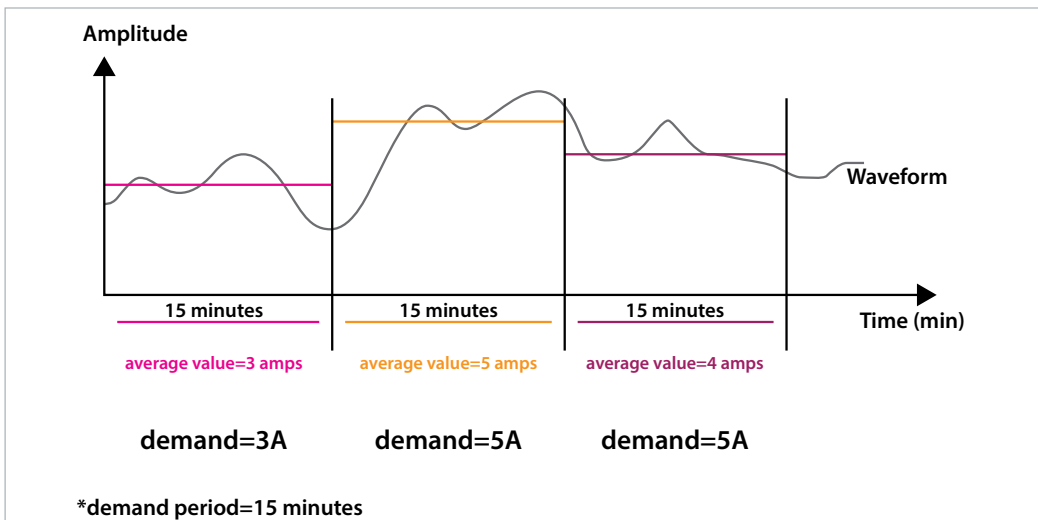

Figure 3-71 Demand Example

3.2.2.2.1 Current Month Menu

This menu displays demand values of current, active, reactive and apparent power of three phases and their totals for the current (present) month.

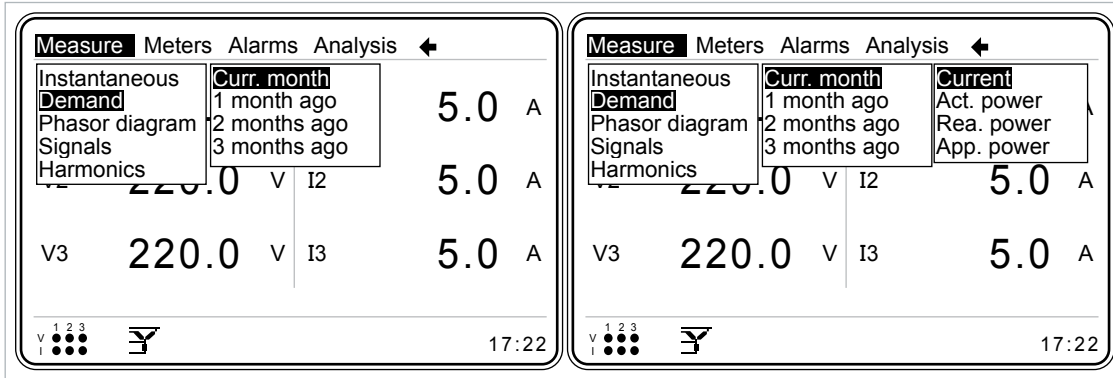

Figure 3-72 Current Month Menu

“Start of day” and “start of month” settings are adjusted in “Settings->Setup->Energy” menu. “Start of day” and “start of month” are important for “Curr. Month”, “1 month ago”, “2 months ago” and “3 months ago” submenus.

Example:

Assume that start of day is “8”, and start of month is “26”;
When time is 08.00 on 26th day of the month;

“Current month” values will be assigned as → “1 month ago” values,
“1 month ago” values will be assigned as → “2 months ago” values,
“2 months ago” values will be assigned as → “3 months ago” values.
And new values will be saved in “current month” menu.

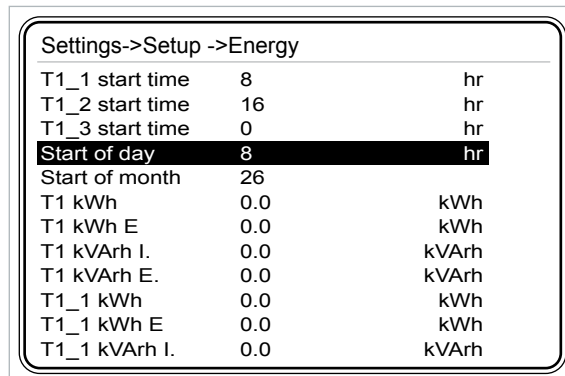

Figure 3-73 Example of Current Month Menu

3.2.2.2.1.1 Current Menu

This menu shows demand values of currents of each phase and the demand value for the sum of phase currents. Date and time information for demand values can be seen on the screen.

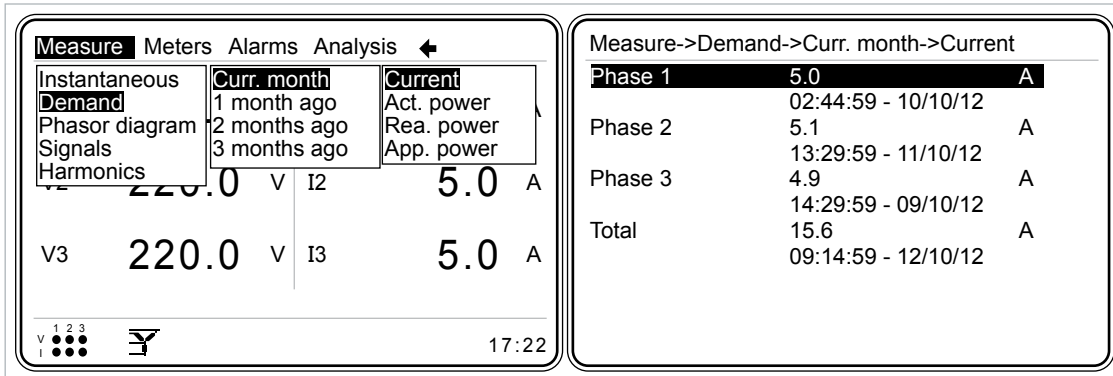

Figure 3-74 Current Menu

Example:

Assume that demand period is entered as 15 minutes. Also assume that the current (present) month's 'current demand' and date are: Phase1 5.0 A 02:44:59 - 10/10/12. This means:

On October 10, 2012, demand value of phase1 current in the time interval 02:29:59 – 02:44:59, is 5.0 A.



In order for KLEA to keep demand values for "1 month ago", "2 months ago" and "3 months ago"; demand period should be set as 1, 2, 3, 4, 5, 6, 10, 12, 15, 20, 30 or 60 min (common divisors of 60). Otherwise, "1 month ago", "2 months ago" and "3 months ago" demand values will not be stored.

Example:

When the system clock is 15:07:00, assume that demand period is adjusted as 15 minutes. Sequentially, demand periods will be as follows:

- 05:07:00 - 15:14:59 = The 1st demand period
- 15:14:59 - 15:29:59 = The 2nd demand period
- 15:29:59 - 15:44:59 = The 3rd demand period
- 15:44:59 - 15:59:59 = The 4th demand period
- 15:59:59 - 16:14:59 = The 5th demand period

3.2.2.2.1.2 Active power menu

The demand values for active power are as explained in the “Demand->Current Month->Current” submenu.

3.2.2.2.1.3 Reactive power menu

The demand values on the reactive power are as explained in the “Demand->Current Month->Current” submenu.

3.2.2.2.1.4 Apparent power menu

The demand values on the apparent power are as explained in the “Demand->Current Month->Current” submenu.

3.2.2.2.2 1 month Ago Menu

The demand values on the 1 month ago menu are as explained in the “Demand->Current Month” submenu.

3.2.2.2.3 2 Months Ago Menu

The demand values on the 2 months ago menu are as explained in the “Demand->Current Month” submenu.

3.2.2.2.4 3 Months Ago Menu

The demand values on the 3 months ago menu are as explained in the “Demand->Current Month” submenu.

3.2.2.3 Phasor Diagram Menu

In phasor diagram menu page, at the right of the phasor diagram, following information is listed:

- phase voltages (V1, V2, V3)
- phase currents (I1, I2, I3)
- V1-V2, V2-V3 and V3-V1 phase difference angles
- V1-I1, V2-I2 and V3-I3 phase difference angles

Within the phasor diagram, currents are drawn with gray lines, and voltages are drawn with black lines.

Within the phasor diagram, same size circles have been added to the ends of lines belonging to the same phase. Thus, it will be easy to follow currents and voltages of a phase.

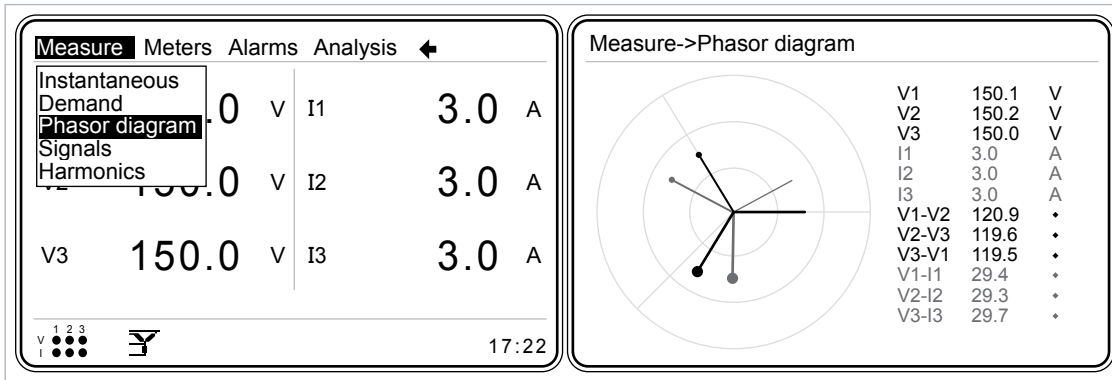

Figure 3-75 Phasor Diagram Menu

3.2.2.4 Signals Menu

In this menu, current and voltage waveforms are shown. At the right hand side of the waveforms, following information is listed:

- Voltage and current values of phases
- Instantaneous frequency value
- Phase difference between current and voltage

Current signal is in gray, and voltage is in black color. Operator can scroll inside signals menu by pressing left and right keys.

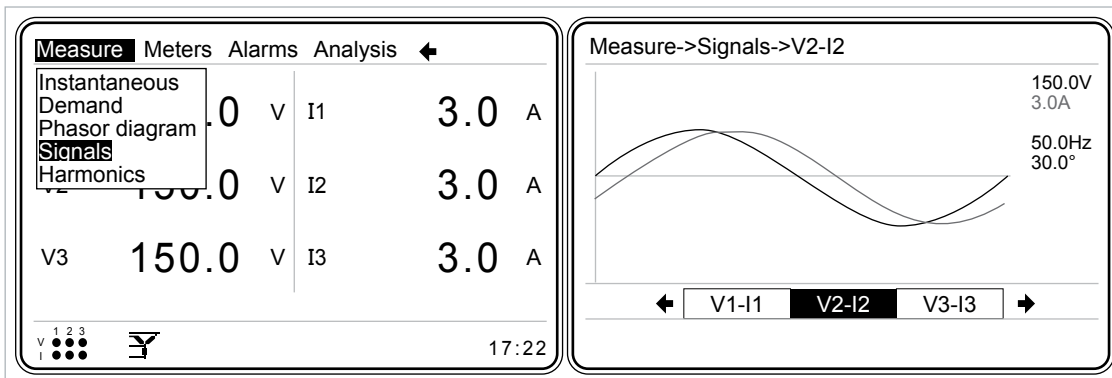

Figure 3-76 Signals Menu

3.2.2.5 Harmonics Menu

KLEA measures/calculates current and voltage harmonics up to 51st harmonic. Current and voltage harmonics can be monitored in table and in graph format.

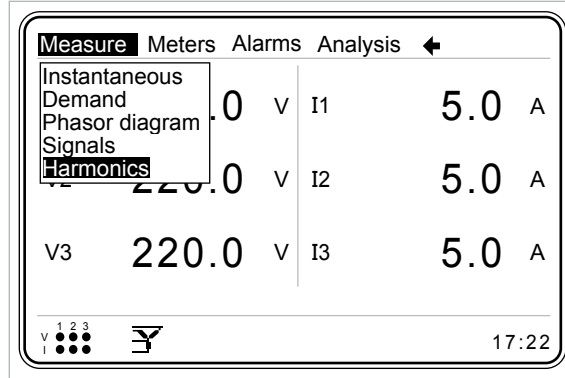

Figure 3-77 Harmonics Menu

3.2.2.5.1 Table Menu

Current and voltage harmonics of each phase are displayed in a table format (See Figure 3-78). Operator can scroll inside table menu by pressing right and left keys. There are 6 table pages: V1, V2, V3, I1, I2, I3.

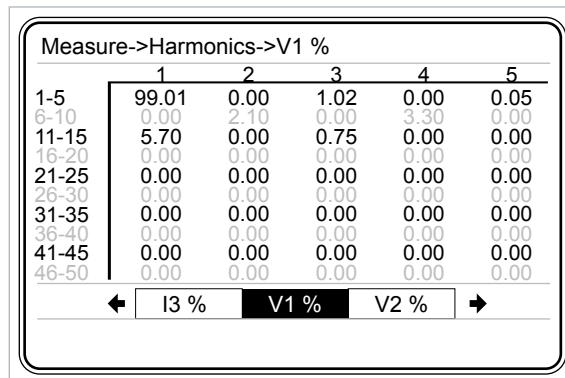

Figure 3-78 Harmonics in Table Format

3.2.2.5.2 Graph Menu

Current and voltage harmonics of each phase are displayed graphically (See Figure 3-79). Operator can scroll inside graph menu by pressing right and left keys. There are 6 graph pages: V1, V2, V3, I1, I2, I3.

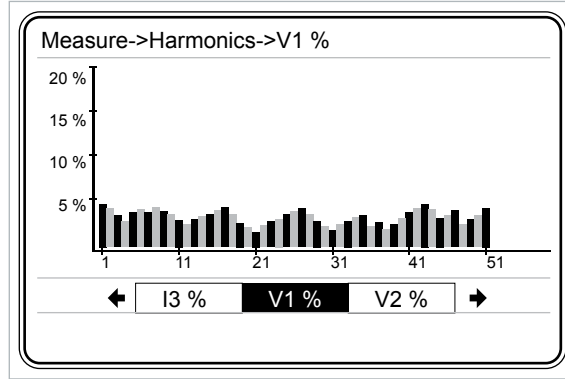

Figure 3-79 Harmonics in Graphical Format

3.2.3 Meters Menu

In this menu, the energy values of Tariff 1 and Tariff 2 meters are displayed:

- Import active
- Export active
- Import reactive
- Export reactive



When an energy meter reaches the value "50000000.0 Mega", it will start to count from "0.0".

3.2.3.1 Tariff 1 Menu

T1 meter consists of "import active", "export active", "import reactive" and "export reactive" energy values.

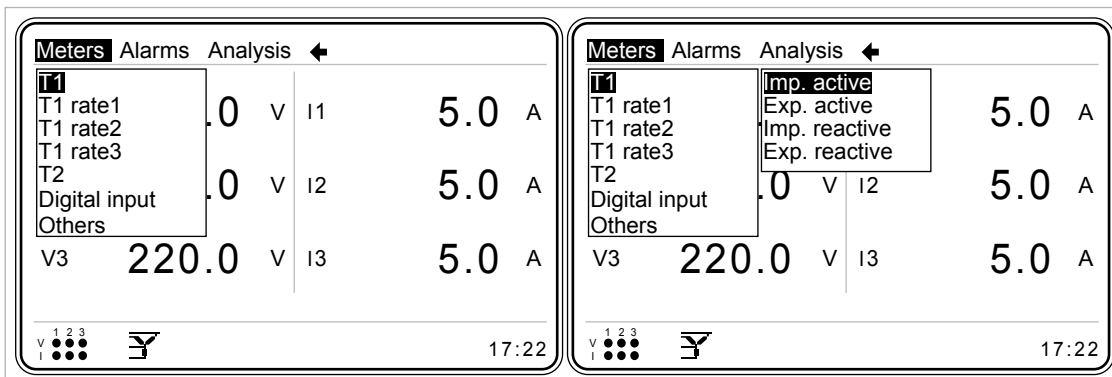

Figure 3-80 Tariff 1 Menu

3.2.3.1.1 Imp. Active Menu (Import Active Energy Menu)

Import active energy values are displayed as seen in the following figure:

Meters->T1->Imp. active		
Index	267500.1	kWh
Curr. hour	0.5	kWh
Prev. hour	0.6	kWh
Curr. day	21.3	kWh
Prev. day	22.6	kWh
Curr. month	598.4	kWh
Prev. month	439.5	kWh

Figure 3-81 Imp. Active Energy Page

Index, active energy consumed up to present time.

Current hour, active energy value consumed from the beginning of current hour up to present time.

Previous hour, is the active energy value consumed during the previous hour.

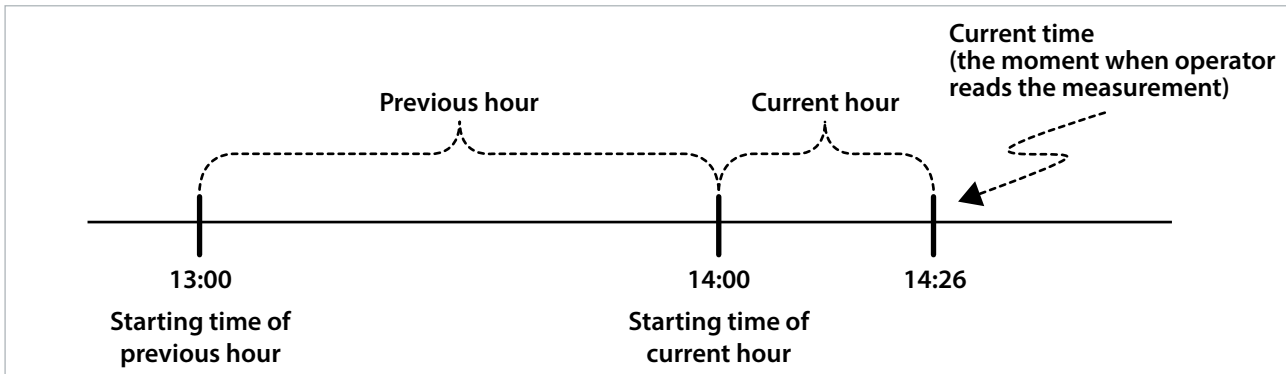

Figure 3-82 Example for Start of Hour

Current day is the active energy value consumed from 'start of day' up to present time.

Previous day, is the active energy value consumed during the previous day.

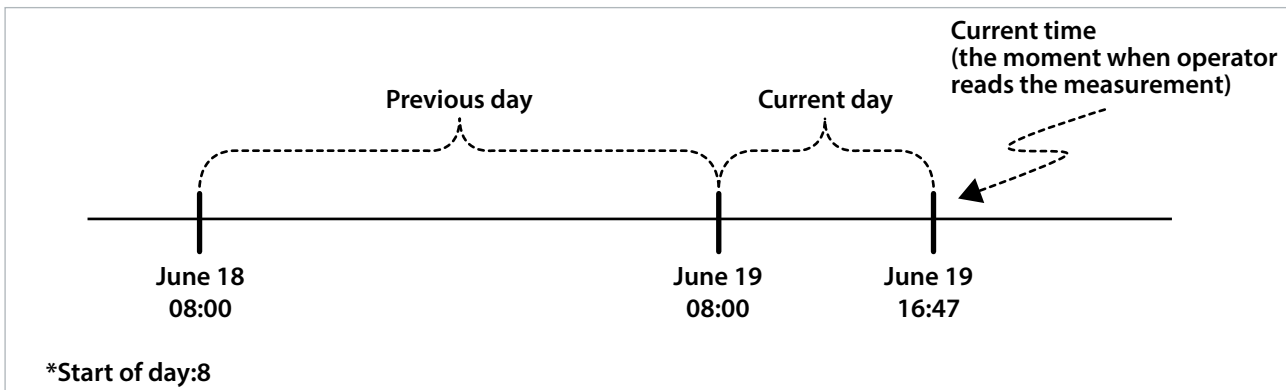

Figure 3-83 Example for Start of Day

Current month is the active energy value consumed from 'start of month' up to present time.
Previous month is the active energy value consumed during the previous month.

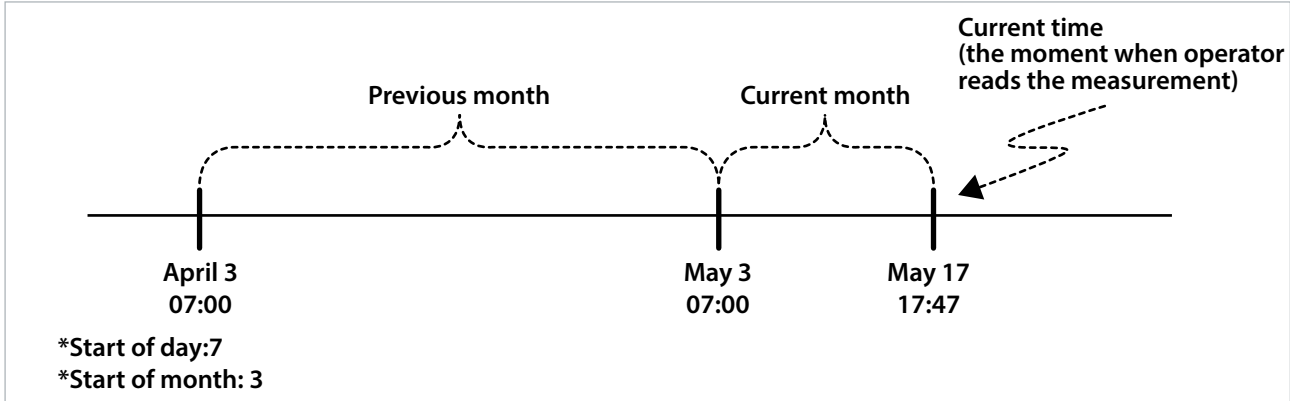

Figure 3-84 Example for Start of Month

'Start of day' and 'start of month' parameters can be adjusted in "Settings->Setup->Energy" menu.

Example:

Assume that 'start of day' is adjusted as "0". In this case, when the system clock is 00:00, value in the "Current day" will be assigned to "previous day". "Current day" resets and starts to count from zero.

Example:

Assume that 'start of month' is adjusted as "1" and 'start of day' is adjusted as "0". In this case, when system time is 00:00 and day of month is 1, "Current month" will be assigned to "previous month". "Current month" resets and starts to count from zero.

3.2.3.1.2 Exp. Active Menu (The Consumed Active Energy Menu)

"Exp. active" menu consists of the same items as "Imp. active" menu. Please refer to 3.2.3.1.1 (Meters->Tariff 1->Imp. active) energy menu for details.

3.2.3.1.3 Imp. reactive Menu (Import Reactive Energy Menu)

"Imp. reactive" menu consists of the same items as "Imp. active" menu. Please refer to 3.2.3.1.1 (Meters->Tariff 1->Imp. active) energy menu for details.

3.2.3.1.4 Exp. reactive Menu (Export Reactive Energy Menu)

"Exp. reactive" menu consists of the same items as "Imp. active" menu. Please refer to 3.2.3.1.1 (Meters->Tariff 1->Imp. active) energy menu for details.

3.2.3.2 T1 Rate1 Menu

T1 rate1 meter, counts between 'T1_1 start time' and 'T1_2 start time'.

Refer to [3.2.1.1.3.1](#) and [3.2.1.1.3.2](#) for 'T1_1 start time' and 'T1_2 start time' settings.

T1 rate1 menu items are the same as [3.1.3.1 Tariff 1](#) menu items.

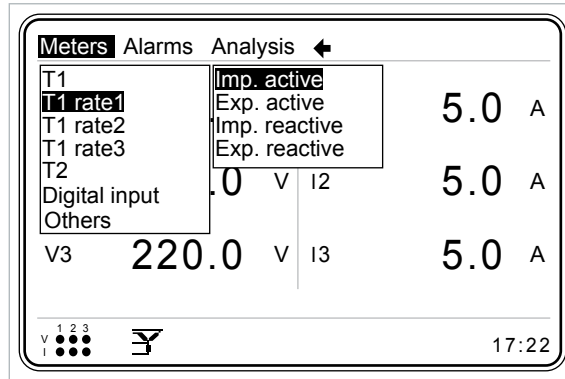

Figure 3-85 T1 Rate1 Menu

3.2.3.3 T1 Rate2 Menu

T1 rate2 meter, counts between 'T1_2 start time' and 'T1_3 start time'.

Refer to [3.2.1.1.3.2](#) and [3.2.1.1.3.3](#) for 'T1_2 start time' and 'T1_3 start time' settings.

T1 rate2 menu items are the same as [3.1.3.1 Tariff 1](#) menu items.

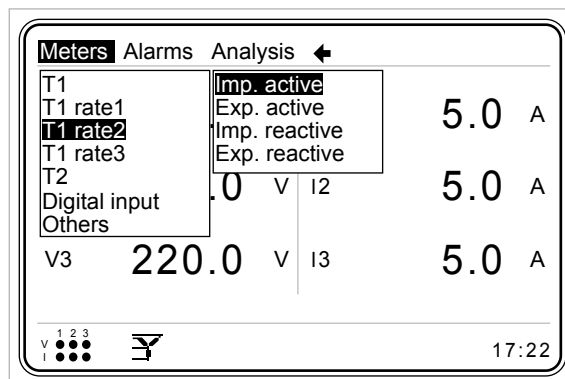

Figure 3-86 T1 Rate2 Menu

3.2.3.4 T1 Rate3 Menu

T1 rate3 meter, counts between 'T1_3 start time' and 'T1_1 start time'.

Refer to 3.2.1.1.3.3 and 3.2.1.1.3.1 for 'T1_3 start time' and 'T1_1 start time' settings.

T1 rate3 menu items are the same as 3.2.3.1 Tariff 1 menu items.

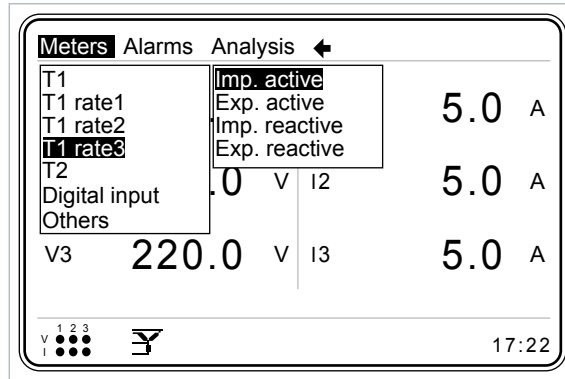

Figure 3-87 T1 Rate3 Menu

3.2.3.5 Tariff 2 Menu

T2 meter consists of "import active", "export active", "import reactive" and "export reactive" energy values. Refer to "3.2.1.1.4.1 Mode Setting" in order to activate Tariff 2 meter.

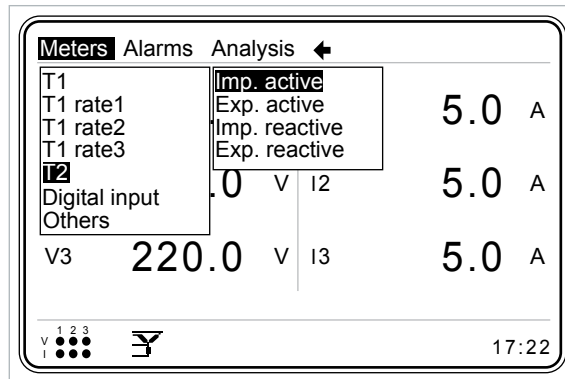

Figure 3-88 Tariff 2 Menu

Tariff 2 menu items are the same as "Tariff 1" menu items.



While Tariff 2 meter is active; Tariff 1, T1 rate1, T1 rate2, T1 rate3 meters are not active. (mutually exclusive).



In order for Tariff 2 to be active;
 1-) "T2" mode should be selected in "digital input1" and/or "digital input2" menu,
 2-) DI and GND pins of the selected input should be short-circuited.
 (Refer to [3.2.1.1.4 Digital input](#)).



If 'Tariff 2' mode is "NOT" SELECTED in the digital input menu, even though the related digital input pins are short-circuited, Tariff 2 will not be active - Tariff 1 meter continues to operate.

3.2.3.6 Digital Input Menu

In this menu, counters belonging to digital inputs are displayed. Refer to [3.2.1.1.4 Digital input](#) to adjust a digital input as a counter.

When DI1 and GND pins are short-circuited for at least delay (Refer to [3.2.1.1.4.1.2 Delay](#)), time, "digital input1 counter" value increments by "1".

When DI2 and GND pins are short-circuited for at least delay (Refer to [3.2.1.1.4.1.2 Delay](#)), time, "digital input2 counter" value increments by "1".

Meters->Digital input	
Counter 1	4
Counter 2	2
Counter 3	0
Counter 4	0
Counter 5	0
Counter 6	0
Counter 7	0

Figure 3-89 Digital Input Menu (Optional Digital I/O model)



KLEA base model has 2; optional digital IO model has 7 counters.

3.2.3.7 Others Menu

In this menu, consist of on hour counter, run hour counter and power interruption counter. Only run hour counter can be deleted by users.

3.2.4 Alarms Menu

In this menu, alarms can be monitored. Alarms menu consists of 'Phase1', 'Phase2', 'Phase3' and 'Other' submenus.

In Klea MODBUS table, 50 alarm statuses can be saved (Refer to Table 4.3). If the number of alarm statuses exceeds 50; 51st alarm is overwritten on the first alarm.

An alarm status consists of the below information:

Alarm Time Stamp:

Alarm time, 32 bit integer

Alarm Definition:

Alarm flag bit number. Refer to the example below.

Alarm State:

Alarm ON or alarm OFF state. Alarm ON and alarm OFF conditions are both considered as records. As a result, both conditions are saved in MODBUS table as different alarm statuses.

1 -> Alarm ON

0 -> Alarm OFF

Alarm Value:

Value of the related alarm parameter

Example:

Assume that, 100 VAC is assigned as low limit for V(L-N) (for phase1, phase2 and phase3 V L-N voltages) and again assume that phase3 voltage falls below 100VAC in the system. In such a case,

Alarm Definition; is the bitwise index number inside the alarm flags (4.5.1.1 Alarm flags) variable. That is, for the above situation, "alarm definition value" will be 3.

Shortly, alarm definition value can be used as an index in alarm flag variable to reach the explanation for that alarm. Besides, this way, operator will have the opportunity to match the alarm with the alarm flag.

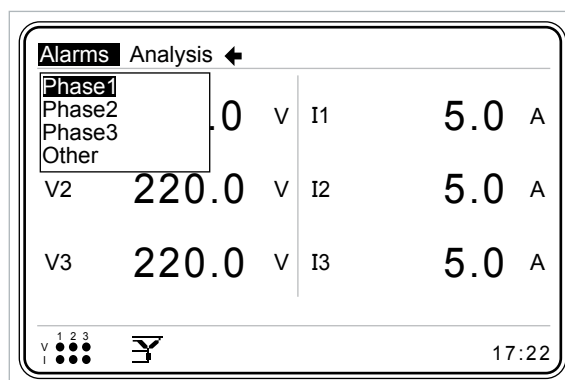

Figure 3-90 Alarms Menu

3.2.4.1 Phase1 Menu

In Phase1 menu, phase1 alarm statuses are displayed.

“Normal” → No alarm

“Alarm” → Alarm

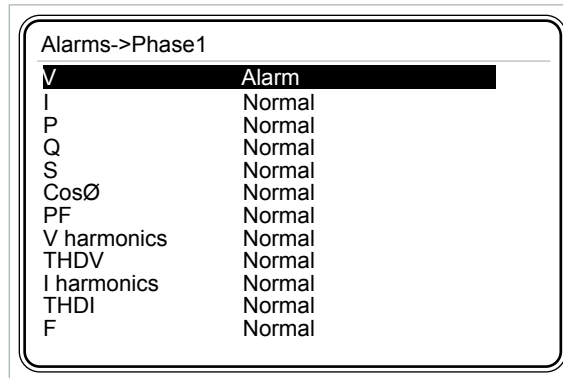

Alarms->Phase1	
V	Alarm
I	Normal
P	Normal
Q	Normal
S	Normal
CosØ	Normal
PF	Normal
V harmonics	Normal
THDV	Normal
I harmonics	Normal
THDI	Normal
F	Normal

Figure 3-91 Phase1 Menu

In Phase1 menu, following alarm statuses are monitored.

- V (phase-neutral voltage)
- I (current)
- P (active power)
- Q (reactive power)
- S (apparent power)
- cos Ø
- PF (power factor)
- V harmonics (any of 3., 5., - 21. harmonic alarm statuses ORed)
- THDV (total harmonic distortion in voltage)
- I harmonics (any of 3., 5., - 21. harmonic alarm statuses ORed)
- THDI (total harmonic distortion in current)

3.2.4.2 Phase2 Menu

“Phase2” menu consists of the same items as “Phase1” menu. Please refer to 3.2.4.1 Phase1 menu for details.

3.2.4.3 Phase3 Menu

“Phase3” menu consists of the same items as “Phase1” menu. Please refer to 3.2.4.1 Phase1 menu for details.

3.2.4.4 Other Menu

In “Other” menu, explanations are the same as in Phase1 menu.

Alarms->Other	
VLL12	Normal
VLL23	Normal
VLL31	Normal
IN	Alarm
Temperature	Normal
Battery	Normal

Figure 3-92 Other Menu

In “Other” menu, following alarm statuses are monitored:

- VLL12 (phase1-phase2 voltage)
- VLL23 (phase2-phase3 voltage)
- VLL31 (phase3-phase1 voltage)
- IN (neutral current)
- Temperature
- Battery

When the battery voltage falls below 1.9 V value, Klea issues Battery alarm. When Klea issues battery alarm, contact your local authorized dealer (or the nearest authorized dealer).

3.2.5 Analysis Menu

It consists of submenus shown in Figure 3-93.

Analysis menu parameters can also be reached from MODBUS ([Refer to 4.5.3 Archive Records](#)).

Analysis			
Minimum	0.0 V	I1	5.0 A
Maximum			
Average			
Energy			
V2	220.0 V	I2	5.0 A
V3	220.0 V	I3	5.0 A

V 1 2 3 17:22

Figure 3-93 Analysis Menu



Analysis menu parameters are not stored in permanent memory. As a result, all of analysis menu parameters will be cleared when Klea is turned-off.

3.2.5.1 Minimum Menu

It consists of hourly, daily and monthly submenus.

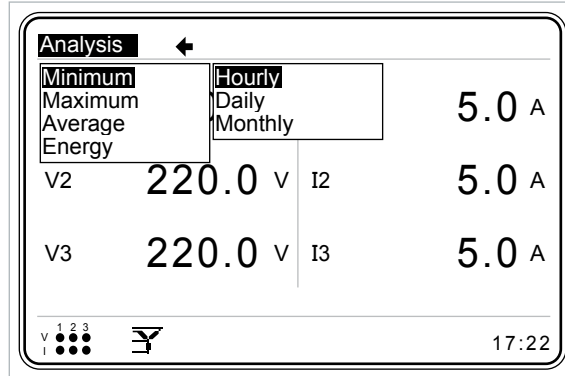

Figure 3-94 Minimum Menu

3.2.5.1.1 Hourly Menu

This menu displays the minimum “instantaneous” values measured/calculated from the beginning of current hour up to present time.

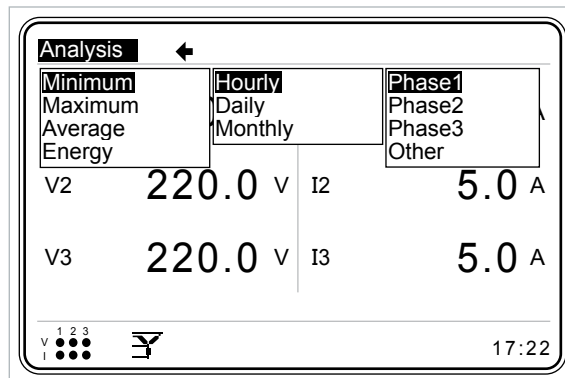

Figure 3-95 Hourly Menu

3.2.5.1.1.1 Phase1 Menu

Voltage(V), current(I), active power(P), reactive power(Q), apparent power(S), $\cos \emptyset$, power factor(PF), and frequency(F) values are displayed.

3.2.5.1.1.2 Phase2 Menu

Voltage(V), current(I), active power(P), reactive power(Q), apparent power(S), $\cos \emptyset$, power factor(PF), and frequency(F) values are displayed.

3.2.5.1.1.3 Phase3 Menu

Voltage(V), current(I), active power(P), reactive power(Q), apparent power(S), $\cos \emptyset$, power factor(PF), and frequency(F) values are displayed.

3.2.5.1.1.4 Other

VLL12(phase1-phase2 voltage), VLL23(phase2- phase3 voltage), VLL31(phase3- phase1 voltage).

3.2.5.1.2 Daily Menu

This menu displays the minimum instantaneous values measured/calculated from start of day (Refer to 3.2.1.1.3.4) up to present time. Its submenus are the same as “Hourly menu”.

3.2.5.1.3 Monthly Menu

This menu displays the minimum instantaneous values measured/calculated from start of month (Refer to 3.2.1.1.3.5) and start of day (Refer to 3.2.1.1.3.4) up to present time. Its submenus are the same as “Hourly menu”.

3.2.5.2 Maximum Menu

Submenus and explanations of “Maximum” menu are the same as “Minimum” menu. The values measured in the “Maximum” menu are also “instantaneous” maximum values.

3.2.5.3 Average Menu

Submenus and explanations of “Maximum” menu are the same as “Minimum” menu. In “Average” menu, hourly, daily and monthly average values are displayed.

3.2.5.4 Energy Menu

In this menu, daily and monthly meter values, which are “measured when Tariff 1 is active”, are displayed.

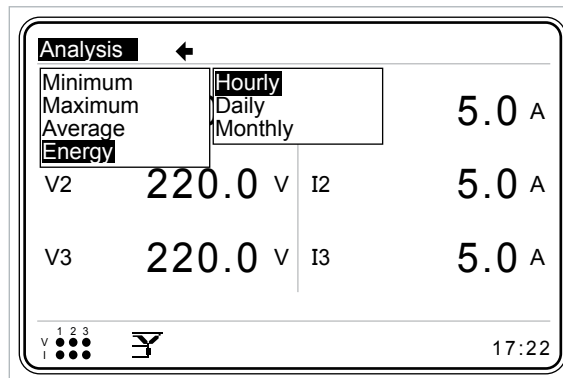

Figure 3-96 Energy Menu



Energy Menu is active only when Tariff 1 is active.

3.2.5.4.1 Hourly Menu

This menu consists of index values measured from the beginning of current hour up to present time.

kWh (import active), kWh E.(export active), kVARh I.(import reactive), kVARh E.(export reactive) index values can be monitored.

3.2.5.4.2 Daily Menu

This menu consists of index values measured from 'start of day' ([Refer to 3.2.1.1.3.4](#)) up to present time.

kWh (import active), kWh E.(export active), kVARh I.(import reactive), kVARh E.(export reactive) index values can be monitored.

3.2.5.4.3 Monthly Menu

This menu consists of index values measured from 'start of month' ([Refer to 3.2.1.1.3.5](#)) and 'start of day' ([Refer to 3.2.1.1.3.4](#)) up to present time.

kWh (import active), kWh E.(export active), kVARh I.(import reactive), kVARh E.(export reactive) index values can be monitored.

A decorative graphic consisting of a cluster of interconnected circles in orange and dark blue. The circles are arranged in a pattern that resembles a molecular structure or a network. The circles are of varying sizes and are connected by thin lines, creating a complex, organic shape. The colors are a vibrant orange and a deep navy blue.

**SECTION 4
MODBUS
PROTOCOL**

SECTION 4 MODBUS PROTOCOL

4.1 RS485 Wiring Diagram

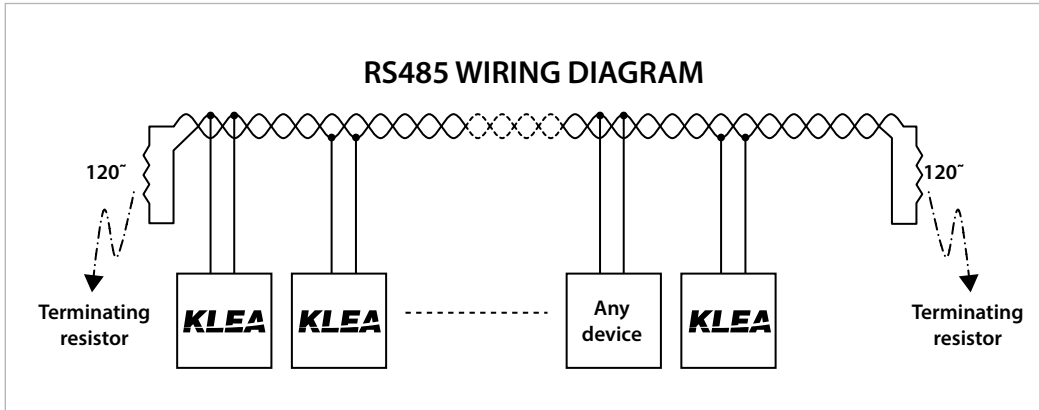

Figure 4-1 RS485 Wiring Diagram

4.2 Computer Connection

KLEA can communicate with PCs via USB-RS85 or RS232-RS485 converters.

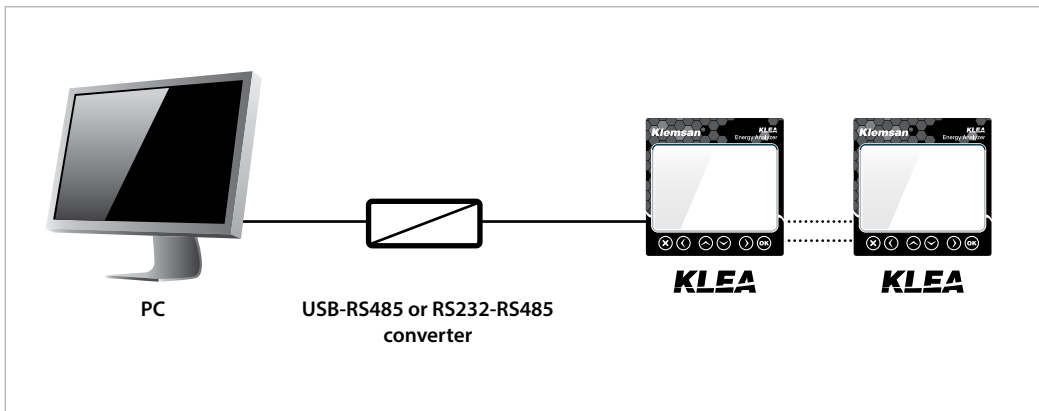

Figure 4-2 Connection of KLEA to a PC



4.3 Message Format and Data Types of MODBUS-RTU Protocol

KLEA implements modbus RTU protocol. Modbus RTU message format is as follows.

Table 4-1 Message Format

Start	Address	Function	Data	CRC	End
≥ 3.5 byte	1 byte	1 byte	0-252 byte	2 byte	≥ 3.5 byte

There should be a time gap, which is at least 3.5 characters wide, between RTU messages.

For instance, when client device requests any information, server device should reply after at least a 3.5 character wide time gap. Following the response of the server, client device should wait 3.5 characters long period, before requesting information again.

Data types used in KLEA are as follows.

Table 4-2 int (32 bit) data type

b31 (Bit 31)	-----	b0 (Bit 0)
MSB (Most Significant Bit)	-----	LSB (Least Significant Bit)

int:

32-bit integer value. Byte order starts from the lowest byte address as b0, b1, b2 and so on.

float:

It is a 32-bit floating-point number in IEEE 754 standard.

string:

Character array in ASCII standard. It is only used for Klea device name and Klea configuration name variables.

4.4 Implemented functions for MODBUS-RTU Protocol

Table 4-3 Implemented functions for MODBUS RTU Protocol

Function Name	Function Code
Read Holding Registers	03H (decimal value 3)
Write Single Register	06H (decimal value 6)
Write Multiple Registers	10H (decimal value 16)
Read file record	14H (decimal value 20)



4.5 Data and Setting Parameters for KLEA

4.5.1 Measured and Calculated Data



Calculated and measured data are “read-only” values.

Operator/programmer can reach all measured and calculated data via MODBUS RTU protocol. Starting address for measured and calculated data is 0.

Example:

Three phase average voltage is read via the 0th and 1th registers (16 bits + 16 bits = 32 bit).

PC (or PLC) Request		KLEA Response	
Slave ID	01h	Slave ID	01h
Function code	03h	Function code	03h
Register address – high	00h	Byte counts	04h
Register address – low	00h	Register value - high (0)	43h
Number of registers– high	00h	Register value - low (0)	5DH
Number of registers – low	02h	Register value - high (1)	36H
CRC high	C4h	Register value - low (1)	E0h
CRC low	0Bh	CRC high	68h
		CRC low	4Dh

The “Byte counts” information of KLEA response is two times “Number of registers” value of “PC request” (1 register = 2 bytes).

Register value high(0) and low(0) together with register value high(1) and low(1) constitute a 32-bit value. This value should be converted (typecasted) to a float value. The float value of the mentioned 32-bit variable is 221.2143555.

Table 4-4 Read-only Data

Address	Parameter	Description	R/W	Unit	Data Type
0	V ave.	Average voltage of three phases	RO	V	32 bit float
2	I tot.	Total current of three phases	RO	A	32 bit float
4	P tot.	Total active power of three phases	RO	W	32 bit float
6	Q tot.	Total reactive power of three phases	RO	VAr	32 bit float
8	S tot.	Total apparent power of three phases	RO	VA	32 bit float
10	CosØ ave.	Average CosØ of three phases	RO	-	32 bit float
12	PF ave.	Average PF of three phases	RO	-	32 bit float
14	VLL1	Voltage V1-2	RO	V	32 bit float
16	VLL2	Voltage V2-3	RO	V	32 bit float
18	VLL3	Voltage V3-1	RO	V	32 bit float
20	VLL ave.	Average of line to line voltage of three phases	RO	V	32 bit float
22	IN	Neutral current	RO	A	32 bit float
24	THDV tot.	Total har. distortion of voltage for three phases	RO	%	32 bit float
26	THDI tot.	Total har. distortion of voltage for three phases	RO	%	32 bit float
PHASE 1					
28	L1 V	Phase1 voltage	RO	V	32 bit float
30	L1 I	Phase1 current	RO	A	32 bit float
32	L1 P	Phase1 active power	RO	W	32 bit float
34	L1 Q	Phase1 reactive power	RO	VAr	32 bit float
36	L1 S	Phase1 apparent power	RO	VA	32 bit float
38	L1 CosØ	Phase1 CosØ	RO	-	32 bit float
40	L1 PF	Phase1 power factor	RO	-	32 bit float
42	L1 F	Phase1 frequency	RO	Hz	32 bit float
44	L1 THDV	Phase1 total har. distortion of voltage	RO	%	32 bit float
46	L1 THDI	Phase1 total har. distortion of current	RO	%	32 bit float
48	L1 V Harmonics1	Phase1 voltage first harmonic	RO	%	32 bit float
50	L1 V Harmonics3	Phase1 voltage third harmonic	RO	%	32 bit float
52	L1 V Harmonics5	Phase1 voltage 5th harmonic	RO	%	32 bit float
54	L1 V Harmonics7	Phase1 voltage 7th harmonic	RO	%	32 bit float
56	L1 V Harmonics9	Phase1 voltage 9th harmonic	RO	%	32 bit float
58	L1 V Harmonics11	Phase1 voltage 11th harmonic	RO	%	32 bit float
60	L1 V Harmonics13	Phase1 voltage 13th harmonic	RO	%	32 bit float
62	L1 V Harmonics15	Phase1 voltage 15th harmonic	RO	%	32 bit float
64	L1 V Harmonics17	Phase1 voltage 17th harmonic	RO	%	32 bit float
66	L1 V Harmonics19	Phase1 voltage 19th harmonic	RO	%	32 bit float
68	L1 V Harmonics21	Phase1 voltage 21st harmonic	RO	%	32 bit float
70	L1 V Harmonics23	Phase1 voltage 23rd harmonic	RO	%	32 bit float
72	L1 V Harmonics25	Phase1 voltage 25th harmonic	RO	%	32 bit float
74	L1 V Harmonics27	Phase1 voltage 27th harmonic	RO	%	32 bit float
76	L1 V Harmonics29	Phase1 voltage 29th harmonic	RO	%	32 bit float
78	L1 V Harmonics31	Phase1 voltage 31st harmonic	RO	%	32 bit float
80	L1 V Harmonics33	Phase1 voltage 33rd harmonic	RO	%	32 bit float
82	L1 V Harmonics35	Phase1 voltage 35th harmonic	RO	%	32 bit float

Address	Parameter	Description	R/W	Unit	Data Type
84	L1 V Harmonics37	Phase1 voltage 37th harmonic	RO	%	32 bit float
86	L1 V Harmonics39	Phase1 voltage 39th harmonic	RO	%	32 bit float
88	L1 V Harmonics41	Phase1 voltage 41st harmonic	RO	%	32 bit float
90	L1 V Harmonics43	Phase1 voltage 43rd harmonic	RO	%	32 bit float
92	L1 V Harmonics45	Phase1 voltage 45th harmonic	RO	%	32 bit float
94	L1 V Harmonics47	Phase1 voltage 47th harmonic	RO	%	32 bit float
96	L1 V Harmonics49	Phase1 voltage 49th harmonic	RO	%	32 bit float
98	L1 V Harmonics51	Phase1 voltage 51st harmonic	RO	%	32 bit float
100	L1 I Harmonics1	Phase1 current first harmonic	RO	%	32 bit float
102	L1 I Harmonics3	Phase1 current third harmonic	RO	%	32 bit float
104	L1 I Harmonics5	Phase1 current 5th harmonic	RO	%	32 bit float
106	L1 I Harmonics7	Phase1 current 7th harmonic	RO	%	32 bit float
108	L1 I Harmonics9	Phase1 current 9th harmonic	RO	%	32 bit float
110	L1 I Harmonics11	Phase1 current 11th harmonic	RO	%	32 bit float
112	L1 I Harmonics13	Phase1 current 13th harmonic	RO	%	32 bit float
114	L1 I Harmonics15	Phase1 current 15th harmonic	RO	%	32 bit float
116	L1 I Harmonics17	Phase1 current 17th harmonic	RO	%	32 bit float
118	L1 I Harmonics19	Phase1 current 19th harmonic	RO	%	32 bit float
120	L1 I Harmonics21	Phase1 current 21st harmonic	RO	%	32 bit float
122	L1 I Harmonics23	Phase1 current 23rd harmonic	RO	%	32 bit float
124	L1 I Harmonics25	Phase1 current 25th harmonic	RO	%	32 bit float
126	L1 I Harmonics27	Phase1 current 27th harmonic	RO	%	32 bit float
128	L1 I Harmonics29	Phase1 current 29th harmonic	RO	%	32 bit float
130	L1 I Harmonics31	Phase1 current 31st harmonic	RO	%	32 bit float
132	L1 I Harmonics33	Phase1 current 33rd harmonic	RO	%	32 bit float
134	L1 I Harmonics35	Phase1 current 35th harmonic	RO	%	32 bit float
136	L1 I Harmonics37	Phase1 current 37th harmonic	RO	%	32 bit float
138	L1 I Harmonics39	Phase1 current 39th harmonic	RO	%	32 bit float
140	L1 I Harmonics41	Phase1 current 41st harmonic	RO	%	32 bit float
142	L1 I Harmonics43	Phase1 current 43rd harmonic	RO	%	32 bit float
144	L1 I Harmonics45	Phase1 current 45th harmonic	RO	%	32 bit float
146	L1 I Harmonics47	Phase1 current 47th harmonic	RO	%	32 bit float
148	L1 I Harmonics49	Phase1 current 49th harmonic	RO	%	32 bit float
150	L1 I Harmonics51	Phase1 current 51st harmonic	RO	%	32 bit float
PHASE 2					
152	L2 V	Phase2 voltage	RO	V	32 bit float
154	L2 I	Phase2 current	RO	A	32 bit float
156	L2 P	Phase2 active power	RO	W	32 bit float
158	L2 Q	Phase2 reactive power	RO	VAr	32 bit float
160	L2 S	Phase2 apparent power	RO	VA	32 bit float
162	L2 CosØ	Phase2 CosØ	RO	-	32 bit float
164	L2 PF	Phase2 power factor	RO	-	32 bit float
166	L2 F	Phase2 frequency	RO	Hz	32 bit float
168	L2 THDV	Phase2 total har. distortion of voltage	RO	%	32 bit float

Address	Parameter	Description	R/W	Unit	Data Type
170	L2 THDI	Phase2 total har. distortion of current	RO	%	32 bit float
172	L2 V Harmonics1	Phase2 voltage first harmonic	RO	%	32 bit float
174	L2 V Harmonics3	Phase2 voltage third harmonic	RO	%	32 bit float
176	L2 V Harmonics5	Phase2 voltage 5th harmonic	RO	%	32 bit float
178	L2 V Harmonics7	Phase2 voltage 7th harmonic	RO	%	32 bit float
180	L2 V Harmonics9	Phase2 voltage 9th harmonic	RO	%	32 bit float
182	L2 V Harmonics11	Phase2 voltage 11th harmonic	RO	%	32 bit float
184	L2 V Harmonics13	Phase2 voltage 13th harmonic	RO	%	32 bit float
186	L2 V Harmonics15	Phase2 voltage 15th harmonic	RO	%	32 bit float
188	L2 V Harmonics17	Phase2 voltage 17th harmonic	RO	%	32 bit float
190	L2 V Harmonics19	Phase2 voltage 19th harmonic	RO	%	32 bit float
192	L2 V Harmonics21	Phase2 voltage 21st harmonic	RO	%	32 bit float
194	L2 V Harmonics23	Phase2 voltage 23rd harmonic	RO	%	32 bit float
196	L2 V Harmonics25	Phase2 voltage 25th harmonic	RO	%	32 bit float
198	L2 V Harmonics27	Phase2 voltage 27th harmonic	RO	%	32 bit float
200	L2 V Harmonics29	Phase2 voltage 29th harmonic	RO	%	32 bit float
202	L2 V Harmonics31	Phase2 voltage 31st harmonic	RO	%	32 bit float
204	L2 V Harmonics33	Phase2 voltage 33rd harmonic	RO	%	32 bit float
206	L2 V Harmonics35	Phase2 voltage 35th harmonic	RO	%	32 bit float
208	L2 V Harmonics37	Phase2 voltage 37th harmonic	RO	%	32 bit float
210	L2 V Harmonics39	Phase2 voltage 39th harmonic	RO	%	32 bit float
212	L2 V Harmonics41	Phase2 voltage 41st harmonic	RO	%	32 bit float
214	L2 V Harmonics43	Phase2 voltage 43rd harmonic	RO	%	32 bit float
216	L2 V Harmonics45	Phase2 voltage 45th harmonic	RO	%	32 bit float
218	L2 V Harmonics47	Phase2 voltage 47th harmonic	RO	%	32 bit float
220	L2 V Harmonics49	Phase2 voltage 49th harmonic	RO	%	32 bit float
222	L2 V Harmonics51	Phase2 voltage 51st harmonic	RO	%	32 bit float
224	L2 I Harmonics1	Phase2 current first harmonic	RO	%	32 bit float
226	L2 I Harmonics3	Phase2 current third harmonic	RO	%	32 bit float
228	L2 I Harmonics5	Phase2 current 5th harmonic	RO	%	32 bit float
230	L2 I Harmonics7	Phase2 current 7th harmonic	RO	%	32 bit float
232	L2 I Harmonics9	Phase2 current 9th harmonic	RO	%	32 bit float
234	L2 I Harmonics11	Phase2 current 11th harmonic	RO	%	32 bit float
236	L2 I Harmonics13	Phase2 current 13th harmonic	RO	%	32 bit float
238	L2 I Harmonics15	Phase2 current 15th harmonic	RO	%	32 bit float
240	L2 I Harmonics17	Phase2 current 17th harmonic	RO	%	32 bit float
242	L2 I Harmonics19	Phase2 current 19th harmonic	RO	%	32 bit float
244	L2 I Harmonics21	Phase2 current 21st harmonic	RO	%	32 bit float
246	L2 I Harmonics23	Phase2 current 23rd harmonic	RO	%	32 bit float
248	L2 I Harmonics25	Phase2 current 25th harmonic	RO	%	32 bit float
250	L2 I Harmonics27	Phase2 current 27th harmonic	RO	%	32 bit float
252	L2 I Harmonics29	Phase2 current 29th harmonic	RO	%	32 bit float
254	L2 I Harmonics31	Phase2 current 31st harmonic	RO	%	32 bit float
256	L2 I Harmonics33	Phase2 current 33rd harmonic	RO	%	32 bit float

Address	Parameter	Description	R/W	Unit	Data Type
258	L2 I Harmonics35	Phase2 current 35th harmonic	RO	%	32 bit float
260	L2 I Harmonics37	Phase2 current 37th harmonic	RO	%	32 bit float
262	L2 I Harmonics39	Phase2 current 39th harmonic	RO	%	32 bit float
264	L2 I Harmonics41	Phase2 current 41st harmonic	RO	%	32 bit float
266	L2 I Harmonics43	Phase2 current 43rd harmonic	RO	%	32 bit float
268	L2 I Harmonics45	Phase2 current 45th harmonic	RO	%	32 bit float
270	L2 I Harmonics47	Phase2 current 47th harmonic	RO	%	32 bit float
272	L2 I Harmonics49	Phase2 current 49th harmonic	RO	%	32 bit float
274	L2 I Harmonics51	Phase2 current 51st harmonic	RO	%	32 bit float
PHASE 3					
276	L3 V	Phase3 voltage	RO	V	32 bit float
278	L2 I	Phase3 current	RO	A	32 bit float
280	L3 P	Phase3 active power	RO	W	32 bit float
282	L3 Q	Phase3 reactive power	RO	VAr	32 bit float
284	L3 S	Phase3 apparent power	RO	VA	32 bit float
286	L3 CosØ	Phase3 CosØ	RO	-	32 bit float
288	L3 PF	Phase3 power factor	RO	-	32 bit float
290	L3 F	Phase3 frequency	RO	Hz	32 bit float
292	L3 THDV	Phase3 total har. distortion of voltage	RO	%	32 bit float
294	L3 THDI	Phase3 total har. distortion of current	RO	%	32 bit float
296	L3 V Harmonics1	Phase3 voltage first harmonic	RO	%	32 bit float
298	L3 V Harmonics3	Phase3 voltage third harmonic	RO	%	32 bit float
300	L3 V Harmonics5	Phase3 voltage 5th harmonic	RO	%	32 bit float
302	L3 V Harmonics7	Phase3 voltage 7th harmonic	RO	%	32 bit float
304	L3 V Harmonics9	Phase3 voltage 9th harmonic	RO	%	32 bit float
306	L3 V Harmonics11	Phase3 voltage 11th harmonic	RO	%	32 bit float
308	L3 V Harmonics13	Phase3 voltage 13th harmonic	RO	%	32 bit float
310	L3 V Harmonics15	Phase3 voltage 15th harmonic	RO	%	32 bit float
312	L3 V Harmonics17	Phase3 voltage 17th harmonic	RO	%	32 bit float
314	L3 V Harmonics19	Phase3 voltage 19th harmonic	RO	%	32 bit float
316	L3 V Harmonics21	Phase3 voltage 21st harmonic	RO	%	32 bit float
318	L3 V Harmonics23	Phase3 voltage 23rd harmonic	RO	%	32 bit float
320	L3 V Harmonics25	Phase3 voltage 25th harmonic	RO	%	32 bit float
322	L3 V Harmonics27	Phase3 voltage 27th harmonic	RO	%	32 bit float
324	L3 V Harmonics29	Phase3 voltage 29th harmonic	RO	%	32 bit float
326	L3 V Harmonics31	Phase3 voltage 31st harmonic	RO	%	32 bit float
328	L3 V Harmonics33	Phase3 voltage 33rd harmonic	RO	%	32 bit float
330	L3 V Harmonics35	Phase3 voltage 35th harmonic	RO	%	32 bit float
332	L3 V Harmonics37	Phase3 voltage 37th harmonic	RO	%	32 bit float
334	L3 V Harmonics39	Phase3 voltage 39th harmonic	RO	%	32 bit float
336	L3 V Harmonics41	Phase3 voltage 41st harmonic	RO	%	32 bit float
338	L3 V Harmonics43	Phase3 voltage 43rd harmonic	RO	%	32 bit float
340	L3 V Harmonics45	Phase3 voltage 45th harmonic	RO	%	32 bit float
342	L3 V Harmonics47	Phase3 voltage 47th harmonic	RO	%	32 bit float

Address	Parameter	Description	R/W	Unit	Data Type
344	L3 V Harmonics49	Phase3 voltage 49th harmonic	RO	%	32 bit float
346	L3 V Harmonics51	Phase3 voltage 51st harmonic	RO	%	32 bit float
348	L3 I Harmonics1	Phase3 current first harmonic	RO	%	32 bit float
350	L3 I Harmonics3	Phase3 current third harmonic	RO	%	32 bit float
352	L3 I Harmonics5	Phase3 current 5th harmonic	RO	%	32 bit float
354	L3 I Harmonics7	Phase3 current 7th harmonic	RO	%	32 bit float
356	L3 I Harmonics9	Phase3 current 9th harmonic	RO	%	32 bit float
358	L3 I Harmonics11	Phase3 current 11th harmonic	RO	%	32 bit float
360	L3 I Harmonics13	Phase3 current 13th harmonic	RO	%	32 bit float
362	L3 I Harmonics15	Phase3 current 15th harmonic	RO	%	32 bit float
364	L3 I Harmonics17	Phase3 current 17th harmonic	RO	%	32 bit float
366	L3 I Harmonics19	Phase3 current 19th harmonic	RO	%	32 bit float
368	L3 I Harmonics21	Phase3 current 21st harmonic	RO	%	32 bit float
370	L3 I Harmonics23	Phase3 current 23rd harmonic	RO	%	32 bit float
372	L3 I Harmonics25	Phase3 current 25th harmonic	RO	%	32 bit float
374	L3 I Harmonics27	Phase3 current 27th harmonic	RO	%	32 bit float
376	L3 I Harmonics29	Phase3 current 29th harmonic	RO	%	32 bit float
378	L3 I Harmonics31	Phase3 current 31st harmonic	RO	%	32 bit float
380	L3 I Harmonics33	Phase3 current 33rd harmonic	RO	%	32 bit float
382	L3 I Harmonics35	Phase3 current 35th harmonic	RO	%	32 bit float
384	L3 I Harmonics37	Phase3 current 37th harmonic	RO	%	32 bit float
386	L3 I Harmonics39	Phase3 current 39th harmonic	RO	%	32 bit float
388	L3 I Harmonics41	Phase3 current 41st harmonic	RO	%	32 bit float
390	L3 I Harmonics43	Phase3 current 43rd harmonic	RO	%	32 bit float
392	L3 I Harmonics45	Phase3 current 45th harmonic	RO	%	32 bit float
394	L3 I Harmonics47	Phase3 current 47th harmonic	RO	%	32 bit float
396	L3 I Harmonics49	Phase3 current 49th harmonic	RO	%	32 bit float
398	L3 I Harmonics51	Phase3 current 51st harmonic	RO	%	32 bit float
ALARM FLAGS					
400	Alarms 1	Alarm flag 1 (first 32 bit)	RO	-	32 bit int.
402	Alarms 2	Alarm flag 2 (second 32 bit)	RO	-	32 bit int.
TARIFF METERS (32 bit)					
404	T1 Imp. Act. Index	Tariff 1 Import Active Index	RO	kWh	32 bit float
406	T1 Imp. Act. Curr. Hour	Tariff 1 Import Active Current Hour	RO	kWh	32 bit float
408	T1 Imp. Act. Prev. Hour	Tariff 1 Import Active Previous Hour	RO	kWh	32 bit float
410	T1 Imp. Act. Curr. Day	Tariff 1 Import. Active Current Day	RO	kWh	32 bit float
412	T1 Imp. Act. Prev. Day	Tariff 1 Import Active Previous Day	RO	kWh	32 bit float
414	T1 Imp. Act. Curr. Month	Tariff 1 Import Active Current Month	RO	kWh	32 bit float
416	T1 Imp. Act. Prev. Month	Tariff 1 Import Previous Month	RO	kWh	32 bit float
418	T1 Exp. Act. Index	Tariff 1 Export Active Index	RO	kWh	32 bit float
420	T1 Exp. Act. Curr. Hour	Tariff 1 Export Active Current Hour	RO	kWh	32 bit float
422	T1 Exp. Act. Prev. Hour	Tariff 1 Export Active Previous Hour	RO	kWh	32 bit float
424	T1 Exp. Act. Curr. Day	Tariff 1 Export Active Current Day	RO	kWh	32 bit float
426	T1 Exp. Act. Prev. Day	Tariff 1 Export Active Previous Day	RO	kWh	32 bit float

Address	Parameter	Description	R/W	Unit	Data Type
428	T1 Exp. Act. Curr. Month	Tariff 1 Export Active Current Month	RO	kWh	32 bit float
430	T1 Exp. Act. Prev. Month	Tariff 1 Export Active Previous Month	RO	kWh	32 bit float
432	T1 Imp. React. Index	Tariff 1 Import Reactive Index	RO	kVAh	32 bit float
434	T1 Imp. React. Curr. Hour	Tariff 1 Import Reactive Current Hour	RO	kVAh	32 bit float
436	T1 Imp. React. Prev. Hour	Tariff 1 Import Reactive Previous Hour	RO	kVAh	32 bit float
438	T1 Imp. React. Curr. Day	Tariff 1 Import Reactive Current Day	RO	kVAh	32 bit float
440	T1 Imp. React. Prev. Day	Tariff 1 Import Reactive Previous Day	RO	kVAh	32 bit float
442	T1 Imp. React. Curr. Month	Tariff 1 Import Reactive Current Month	RO	kVAh	32 bit float
444	T1 Imp. React. Prev. Month	Tariff 1 Import Reactive Previous Month	RO	kVAh	32 bit float
446	T1 Exp. React. Index	Tariff 1 Export Reactive Index	RO	kVAh	32 bit float
448	T1 Exp. React. Curr. Hour	Tariff 1 Export Reactive Current Hour	RO	kVAh	32 bit float
450	T1 Exp. React. Prev. Hour	Tariff 1 Export Reactive Previous Hour	RO	kVAh	32 bit float
452	T1 Exp. React. Curr. Day	Tariff 1 Export Reactive Current Day	RO	kVAh	32 bit float
454	T1 Exp. React. Prev. Day	Tariff 1 Export Reactive Previous Day	RO	kVAh	32 bit float
456	T1 Exp. React. Curr. Month	Tariff 1 Export Reactive Current Month	RO	kVAh	32 bit float
458	T1 Exp. React. Prev. Month	Tariff 1 Export Reactive Previous Month	RO	kVAh	32 bit float
460	T1_1 Imp. Act. Index	T1 Rate1 Import Active Index	RO	kWh	32 bit float
462	T1_1 Imp. Act. Curr. Hour	T1 Rate1 Import Active Current Hour	RO	kWh	32 bit float
464	T1_1 Imp. Act. Prev. Hour	T1 Rate1 Import Active Previous Hour	RO	kWh	32 bit float
466	T1_1 Imp. Act. Curr. Day	T1 Rate1 Import Active Current Day	RO	kWh	32 bit float
468	T1_1 Imp. Act. Prev. Day	T1 Rate1 Import Active Previous Day	RO	kWh	32 bit float
470	T1_1 Imp. Act. Curr. Month	T1 Rate1 Import Active Current Month	RO	kWh	32 bit float
472	T1_1 Imp. Act. Prev. Month	T1 Rate1 Import Active Previous Month	RO	kWh	32 bit float
474	T1_1 Exp. Act. Index	T1 Rate1 Export Active Index	RO	kWh	32 bit float
476	T1_1 Exp. Act. Curr. Hour	T1 Rate1 Export Active Current Hour	RO	kWh	32 bit float
478	T1_1 Exp. Act. Prev. Hour	T1 Rate1 Export Active Previous Hour	RO	kWh	32 bit float
480	T1_1 Exp. Act. Curr. Day	T1 Rate1 Export Active Current Day	RO	kWh	32 bit float
482	T1_1 Exp. Act. Prev. Day	T1 Rate1 Export Active Previous Day	RO	kWh	32 bit float
484	T1_1 Exp. Act. Cur. Month	T1 Rate1 Export Active Current Month	RO	kWh	32 bit float
486	T1_1 Exp. Act. Prev. Month	T1 Rate1 Export Active Previous Month	RO	kWh	32 bit float
488	T1_1 Imp. React. Index	T1 Rate1 Import Reactive Index	RO	kVAh	32 bit float
490	T1_1 Imp. React. Curr. Hour	T1 Rate1 Import Reactive Current Hour	RO	kVAh	32 bit float
492	T1_1 Imp. React. Prev. Hour	T1 Rate1 Import Reactive Previous Hour	RO	kVAh	32 bit float
494	T1_1 Imp. React. Curr. Day	T1 Rate1 Import Reactive Current Day	RO	kVAh	32 bit float
496	T1_1 Imp. React. Prev. Day	T1 Rate1 Import Reactive Previous Day	RO	kVAh	32 bit float
498	T1_1 Imp. React. Curr. Month	T1 Rate1 Import Reactive Current Month	RO	kVAh	32 bit float
500	T1_1 Imp. React. Prev. Month	T1 Rate1 Import Reactive Previous Month	RO	kVAh	32 bit float
502	T1_1 Exp. React. Index	T1 Rate1 Export Reactive Index	RO	kVAh	32 bit float
504	T1_1 Exp. React. Curr. Hour	T1 Rate1 Export Reactive Current Hour	RO	kVAh	32 bit float
506	T1_1 Exp. React. Prev. Hour	T1 Rate1 Export Reactive Previous Hour	RO	kVAh	32 bit float
508	T1_1 Exp. React. Curr. Day	T1 Rate1 Export Reactive Current Day	RO	kVAh	32 bit float
510	T1_1 Exp. React. Prev. Day	T1 Rate1 Export Reactive Previous Day	RO	kVAh	32 bit float
512	T1_1 Exp. React. Curr. Month	T1 Rate1 Export Reactive Current Month	RO	kVAh	32 bit float
514	T1_1 Exp. React. Prev. Month	T1 Rate1 Export Reactive Previous Month	RO	kVAh	32 bit float

Address	Parameter	Description	R/W	Unit	Data Type
516	T1_2 Imp. Act. Index	T1 Rate2 Import Active Index	RO	kWh	32 bit float
518	T1_2 Imp. Act. Curr. Hour	T1 Rate2 Import Active Current Hour	RO	kWh	32 bit float
520	T1_2 Imp. Act. Prev. Hour	T1 Rate2 Import Active Previous Hour	RO	kWh	32 bit float
522	T1_2 Imp. Act. Current Day	T1 Rate2 Import Active Current Day	RO	kWh	32 bit float
524	T1_2 Imp. Act. Prev. Day	T1 Rate2 Import Active Previous Day	RO	kWh	32 bit float
526	T1_2 Imp. Act. Curr. Month	T1 Rate2 Import Active Current Month	RO	kWh	32 bit float
528	T1_2 Imp. Act. Prev. Month	T1 Rate2 Import Active Previous Month	RO	kWh	32 bit float
530	T1_2 Exp. Act. Index	T1 Rate2 Export Active Index	RO	kWh	32 bit float
532	T1_2 Exp. Act. Curr. Hour	T1 Rate2 Export Active Current Hour	RO	kWh	32 bit float
534	T1_2 Exp. Act. Prev. Hour	T1 Rate2 ExportActive Previous Hour	RO	kWh	32 bit float
536	T1_2 Exp. Act. Curr. Day	T1 Rate2 Export Active Current Day	RO	kWh	32 bit float
538	T1_2 Exp. Act. Prev. Day	T1 Rate2 Export Active Previous Day	RO	kWh	32 bit float
540	T1_2 Exp. Act. Curr. Month	T1 Rate2 Export Active Current Month	RO	kWh	32 bit float
542	T1_2 Exp. Act. Prev. Month	T1 Rate2 Export Active Previous Month	RO	kWh	32 bit float
544	T1_2 Imp. React. Index	T1 Rate2 Import Reactive Index	RO	kVArh	32 bit float
546	T1_2 Imp. React. Curr. Hour	T1 Rate2 Import Reactive Current Hour	RO	kVArh	32 bit float
548	T1_2 Imp. React. Prev. Hour	T1 Rate2 Import Reactive Previous Hour	RO	kVArh	32 bit float
550	T1_2 Imp. React. Curr. Day	T1 Rate2 Import Reactive Current Day	RO	kVArh	32 bit float
552	T1_2 Imp. React. Prev. Day	T1 Rate2 Import Reactive Previous Day	RO	kVArh	32 bit float
554	T1_2 Imp. React. Curr. Month	T1 Rate2 Import Reactive Current Month	RO	kVArh	32 bit float
556	T1_2 Imp. React. Prev. Month	T1 Rate2 Import Reactive Previous Month	RO	kVArh	32 bit float
558	T1_2 Exp. React. Index	T1 Rate2 Export Reactive Index	RO	kVArh	32 bit float
560	T1_2 Exp. React. Curr. Hour	T1 Rate2 Export Reactive Current Hour	RO	kVArh	32 bit float
562	T1_2 Exp. React. Prev. Hour	T1 Rate2 Export Reactive Previous Hour	RO	kVArh	32 bit float
564	T1_2 Exp. React. Curr. Day	T1 Rate2 Export Reactive Current Day	RO	kVArh	32 bit float
566	T1_2 Exp. React. Prev. Day	T1 Rate2 Export Reactive Previous Day	RO	kVArh	32 bit float
568	T1_2 Exp. React. Curr. Month	T1 Rate2 Export Reactive Current Month	RO	kVArh	32 bit float
570	T1_2 Exp. React. Prev. Month	T1 Rate2 Export Reactive Previous Month	RO	kVArh	32 bit float
572	T1_3 Imp. Act. Index	T1 Rate3 Import Active Index	RO	kWh	32 bit float
574	T1_3 Imp. Act. Curr. Hour	T1 Rate3 Import Active Current Hour	RO	kWh	32 bit float
576	T1_3 Imp. Act. Prev. Hour	T1 Rate3 Import Active Previous Hour	RO	kWh	32 bit float
578	T1_3 Imp. Act. Curr. Day	T1 Rate3 Import Active Current Day	RO	kWh	32 bit float
580	T1_3 Imp. Act. Prev. Day	T1 Rate3 Import Active Previous Day	RO	kWh	32 bit float
582	T1_3 Imp. Act. Curr. Month	T1 Rate3 Import Active Current Month	RO	kWh	32 bit float
584	T1_3 Imp. Act. Prev. Month	T1 Rate3 Import Active Previous Month	RO	kWh	32 bit float
586	T1_3 Exp. Act. Index	T1 Rate3 Export Active Index	RO	kWh	32 bit float
588	T1_3 Exp. Act. Curr. Hour	T1 Rate3 Export Active Current Hour	RO	kWh	32 bit float
590	T1_3 Exp. Act. Prev. Hour	T1 Rate3 Export Active Previous Hour	RO	kWh	32 bit float
592	T1_3 Exp. Act. Curr. Day	T1 Rate3 Export Active Current Day	RO	kWh	32 bit float
594	T1_3 Exp. Act. Prev. Day	T1 Rate3 Export Active Previous Day	RO	kWh	32 bit float
596	T1_3 Exp. Act. Curr. Month	T1 Rate3 Export Active Current Month	RO	kWh	32 bit float
598	T1_3 Exp. Act. Prev. Month	T1 Rate3 Export Active Previous Month	RO	kWh	32 bit float
600	T1_3 Imp. React. Index	T1 Rate3 Import Reactive Index	RO	kVArh	32 bit float
602	T1_3 Imp. React. Curr. Hour	T1 Rate3 Import Reactive Current Hour	RO	kVArh	32 bit float

Address	Parameter	Description	R/W	Unit	Data Type
604	T1_3 Imp. React. Prev. Hour	T1 Rate3 Import Reactive Previous Hour	RO	kVArh	32 bit float
606	T1_3 Imp. React. Curr. Day	T1 Rate3 Import Reactive Current Day	RO	kVArh	32 bit float
608	T1_3 Imp. React. Prev. Day	T1 Rate3 Import Reactive Previous Day	RO	kVArh	32 bit float
610	T1_3 Imp. React. Curr. Month	T1 Rate3 Import Reactive Current Month	RO	kVArh	32 bit float
612	T1_3 Imp. React. Prev. Month	T1 Rate3 Import Reactive Previous Month	RO	kVArh	32 bit float
614	T1_3 Exp. React. Index	T1 Rate3 Export Reactive Index	RO	kVArh	32 bit float
616	T1_3 Exp. React. Curr. Hour	T1 Rate3 Export Reactive Current Hour	RO	kVArh	32 bit float
618	T1_3 Exp. React. Prev. Hour	T1 Rate3 Export Reactive Previous Hour	RO	kVArh	32 bit float
620	T1_3 Exp. React. Curr. Day	T1 Rate3 Export Reactive Current Day	RO	kVArh	32 bit float
622	T1_3 Exp. React. Prev. Day	T1 Rate3 Export Reactive Previous Day	RO	kVArh	32 bit float
624	T1_3 Exp. React. Curr. Month	T1 Rate3 Export Reactive Current Month	RO	kVArh	32 bit float
626	T1_3 Exp. React. Prev. Month	T1 Rate3 Export Reactive Previous Month	RO	kVArh	32 bit float
628	T2 Imp. Act. Index	Tariff 2 Import Active Index	RO	kWh	32 bit float
630	T2 Imp. Act. Curr. Hour	Tariff 2 Import Active Current Hour	RO	kWh	32 bit float
632	T2 Imp. Act. Prev. Hour	Tariff 2 Import Active Previous Hour	RO	kWh	32 bit float
634	T2 Imp. Act. Curr. Day	Tariff 2 Import Active Current Day	RO	kWh	32 bit float
636	T2 Imp. Act. Prev. Day	Tariff 2 Import Active Previous Day	RO	kWh	32 bit float
638	T2 Imp. Act. Curr. Month	Tariff 2 Import Active Current Month	RO	kWh	32 bit float
640	T2 Imp. Act. Prev. Month	Tariff 2 Import Active Previous Month	RO	kWh	32 bit float
642	T2 Exp. Act. Index	Tariff 2 Export Active Index	RO	kWh	32 bit float
644	T2 Exp. Act. Curr. Hour	Tariff 2 Export Active Current Hour	RO	kWh	32 bit float
646	T2 Exp. Act. Prev. Hour	Tariff 2 Export Active Previous Hour	RO	kWh	32 bit float
648	T2 Exp. Act. Curr. Day	Tariff 2 Export Active Current Day	RO	kWh	32 bit float
650	T2 Exp. Act. Prev. Day	Tariff 2 Export Active Previous Day	RO	kWh	32 bit float
652	T2 Exp. Act. Curr. Month	Tariff 2 Export Active Current Month	RO	kWh	32 bit float
654	T2 Exp. Act. Prev. Month	Tariff 2 Export Active Previous Month	RO	kWh	32 bit float
656	T2 Imp. React. Index	Tariff 2 Import Reactive Index	RO	kVArh	32 bit float
658	T2 Imp. React. Curr. Hour	Tariff 2 Import Reactive Current Hour	RO	kVArh	32 bit float
660	T2 Imp. React. Prev. Hour	Tariff 2 Import Reactive Previous Hour	RO	kVArh	32 bit float
662	T2 Imp. React. Curr. Day	Tariff 2 Import Reactive Current Day	RO	kVArh	32 bit float
664	T2 Imp. React. Prev. Day	Tariff 2 Import Reactive Previous Day	RO	kVArh	32 bit float
666	T2 Imp. React. Curr. Month	Tariff 2 Import Reactive Current Month	RO	kVArh	32 bit float
668	T2 Imp. React. Prev. Month	Tariff 2 Import Reactive Previous Month	RO	kVArh	32 bit float
670	T2 Exp. React. Index	Tariff 2 Export Reactive Index	RO	kVArh	32 bit float
672	T2 Exp. React. Curr. Hour	Tariff 2 Export Reactive Current Hour	RO	kVArh	32 bit float
674	T2 Exp. React. Prev. Hour	Tariff 2 Export Reactive Previous Hour	RO	kVArh	32 bit float
676	T2 Exp. React. Curr. Day	Tariff 2 Export Reactive Current Day	RO	kVArh	32 bit float
678	T2 Exp. React. Prev. Day	Tariff 2 Export Reactive Previous Day	RO	kVArh	32 bit float
680	T2 Exp. React. Curr. Month	Tariff 2 Export Reactive Current Month	RO	kVArh	32 bit float
682	T2 Exp. React. Prev. Month	Tariff 2 Export Reactive Previous Month	RO	kVArh	32 bit float
DEMAND					
684	Curr. Month P tot.	Current Month Total Active Power	RO	W	32 bit float
686	Curr. Month P tot. time	Current Month Total Active Power Timestamp	RO	-	32 bit unix time
688	Curr. Month I tot.	Current Month Total Current	RO	A	32 bit float

Address	Parameter	Description	R/W	Unit	Data Type
690	Curr. Month I tot. time	Current Month Total Current Timestamp	RO	-	32 bit unix time
692	Curr. Month Q tot.	Current Month Total Reactive Power	RO	VAr	32 bit float
694	Curr. Month Q tot. time	Current Month Total Reactive Power Timestamp	RO	-	32 bit unix time
696	Curr. Month S tot.	Current Month Total Apparent Power	RO	VA	32 bit float
698	Curr. Month S tot. time	Current Month Total Apparent Power Timestamp	RO	-	32 bit unix time
700	Curr. Month L1 P	Current Month Phase 1 Active Power	RO	W	32 bit float
702	Curr. Month L1 P time	Current Month Phase 1 Active Power Timestamp	RO	-	32 bit unix time
704	Curr. Month L1 I	Current Month Phase 1 Current	RO	A	32 bit float
706	Curr. Month L1 I time	Current Month Phase 1 Current Timestamp	RO	-	32 bit unix time
708	Curr. Month L1 Q	Current Month Phase 1 Reactive Power	RO	VAr	32 bit float
710	Curr. Month L1 Q time	Current Month Phase 1 Reactive Power Timestamp	RO	-	32 bit unix time
712	Curr. Month L1 S	Current Month Phase 1 Apparent Power	RO	VA	32 bit float
714	Curr. Month L1 S time	Current Month Phase 1 Apparent Power Timestamp	RO	-	32 bit unix time
716	Curr. Month L2 P	Current Month Phase 2 Active Power	RO	W	32 bit float
718	Curr. Month L2 P time	Current Month Phase 2 Active Power Timestamp	RO	-	32 bit unix time
720	Curr. Month L2 I	Current Month Phase 2 Current	RO	A	32 bit float
722	Curr. Month L2 I time	Current Month Phase 2 Current Timestamp	RO	-	32 bit unix time
724	Curr. Month L2 Q	Current Month Phase 2 Reactive Power	RO	VAr	32 bit float
726	Curr. Month L2 Q time	Current Month Phase 2 Reactive Power Timestamp	RO	-	32 bit unix time
728	Curr. Month L2 S	Current Month Phase 2 Apparent Power	RO	VA	32 bit float
730	Curr. Month L2 S time	Current Month Phase 2 Apparent Power Timestamp	RO	-	32 bit unix time
732	Curr. Month L3 P	Current Month Phase 3 Active Power	RO	W	32 bit float
734	Curr. Month L3 P time	Current Month Phase 3 Active Power Timestamp	RO	-	32 bit unix time
736	Curr. Month L3 I	Current Month Phase 3 Current	RO	A	32 bit float
738	Curr. Month L3 I time	Current Month Phase 3 Current Timestamp	RO	-	32 bit unix time
740	Curr. Month L3 Q	Current Month Phase 3 Reactive Power	RO	VAr	32 bit float
742	Curr. Month L3 Q time	Current Month Phase 3 Reactive Power Timestamp	RO	-	32 bit unix time
744	Curr. Month L3 S	Current Month Phase 3 Apparent Power	RO	VA	32 bit float
746	Curr. Month L3 S time	Current Month Phase 3 Apparent Power Timestamp	RO	-	32 bit unix time
748	1 month ago P tot.	1 Month Ago Total Active Power	RO	W	32 bit float
750	1 month ago P tot. time	1 Month Ago Total Active Power Timestamp	RO	-	32 bit unix time
752	1 month ago I tot.	1 Month Ago Total Current	RO	A	32 bit float
754	1 month ago I tot. time	1 Month Ago Total Current Timestamp	RO	-	32 bit unix time
756	1 month ago Q tot.	1 Month Ago Total Reactive Power	RO	VAr	32 bit float
758	1 month ago Q tot. time	1 Month Ago Total Reactive Power Timestamp	RO	-	32 bit unix time
760	1 month ago S tot.	1 Month Ago Total Apparent Power	RO	VA	32 bit float

Address	Parameter	Description	R/W	Unit	Data Type
762	1 month ago S tot. time	1 Month Ago Total Apparent Power Timestamp	RO	-	32 bit unix time
764	1 month ago L1 P	1 Month Ago Phase 1 Active Power	RO	W	32 bit float
766	1 month ago L1 P time	1 Month Ago Phase 1 Active Power Timestamp	RO	-	32 bit unix time
768	1 month ago L1 I	1 Month Ago Phase 1 Current	RO	A	32 bit float
770	1 month ago L1 I time	1 Month Ago Phase 1 Current Timestamp	RO	-	32 bit unix time
772	1 month ago L1 Q	1 Month Ago Phase 1 Reactive Power	RO	VAr	32 bit float
774	1 month ago L1 Q time	1 Month Ago Phase 1 Reactive Power Timestamp	RO	-	32 bit unix time
776	1 month ago L1 S	1 Month Ago Phase 1 Apparent Power	RO	VA	32 bit float
778	1 month ago L1 S time	1 Month Ago Phase 1 Apparent Power Timestamp	RO	-	32 bit unix time
780	1 month ago L2 P	1 Month Ago Phase 2 Active Power Value	RO	W	32 bit float
782	1 month ago L2 P time	1 Month Ago Phase 2 Active Power Timestamp	RO	-	32 bit unix time
784	1 month ago L2 I	1 Month Ago Phase 2 Current Value	RO	A	32 bit float
786	1 month ago L2 I time	1 Month Ago Phase 2 Current Timestamp	RO	-	32 bit unix time
788	1 month ago L2 Q	1 Month Ago Phase 2 Reactive Power	RO	VAr	32 bit float
790	1 month ago L2 Q time	1 Month Ago Phase 2 Reactive Power Timestamp	RO	-	32 bit unix time
792	1 month ago L2 S	1 Month Ago Phase 2 Apparent Power	RO	VA	32 bit float
794	1 month ago L2 S time	1 Month Ago Phase 2 Apparent Power Timestamp	RO	-	32 bit unix time
796	1 month ago L3 P	1 Month Ago Phase 3 Active Power	RO	W	32 bit float
798	1 month ago L3 P time	1 Month Ago Phase 3 Active Power Timestamp	RO	-	32 bit unix time
800	1 month ago L3 I	1 Month Ago Phase 3 Current	RO	A	32 bit float
802	1 month ago L3 I time	1 Month Ago Phase 3 Current Timestamp	RO	-	32 bit unix time
804	1 month ago L3 Q	1 Month Ag Phase 3 Reactive Power	RO	VAr	32 bit float
806	1 month ago L3 Q time	1 Month Ago Phase 3 Reactive Power Timestamp	RO	-	32 bit unix time
808	1 month ago L3 S	1 Month Ago Phase 3 Apparent Power	RO	VA	32 bit float
810	1 month ago L3 S time	1 Month Ago Phase 3 Apparent Power Timestamp	RO	-	32 bit unix time
812	2 months ago Total P	2 Months Ago Total Active Power	RO	W	32 bit float
814	2 months ago Total P time	2 Months Ago Total Active Power Timestamp	RO	-	32 bit unix time
816	2 months ago Total I	2 Months Ago Total Current	RO	A	32 bit float
818	2 months ago Total I	2 Months Ago Total Current Timestamp	RO	-	32 bit unix time
820	2 months ago Q top.	2 Months Ago Total Reactive Power	RO	VAr	32 bit float
822	2 months ago Total Q time	2 Months Ago Total Reactive Power Timestamp	RO	-	32 bit unix time
824	2 months ago Total S	2 Months Ago Total Apparent Power	RO	VA	32 bit float
826	2 months ago Total S time	2 Months Ago Total Apparent Power Timestamp	RO	-	32 bit unix time
828	2 months ago L1 P	2 Months Ago Phase 1 Active Power	RO	W	32 bit float
830	2 months ago L1 P time	2 Months Ago Phase 1 Active Power Timestamp	RO	-	32 bit unix time
832	2 months ago L1 I	2 Months Ago Phase 1 Current	RO	A	32 bit float
834	2 months ago L1 I time	2 Months Ago Phase 1 Current Timestamp	RO	-	32 bit unix time
836	2 months ago L1 Q	2 Months Ago Phase 1 Reactive Power	RO	VAr	32 bit float

Address	Parameter	Description	R/W	Unit	Data Type
838	2 months ago L1 Q time	2 Months Ago Phase 1 Reactive Power Timestamp	RO	-	32 bit unix time
840	2 months ago L1 S	2 Months Ago Phase 1 Apparent Power	RO	VA	32 bit float
842	2 months ago L1 S time	2 Months Ago Phase 1 Apparent Power Timestamp	RO	-	32 bit unix time
844	2 months ago L2 P	2 Months Ago Phase 2 Active Power	RO	W	32 bit float
846	2 months ago L2 P time	2 Months Ago Phase 2 Active Power Timestamp	RO	-	32 bit unix time
848	2 months ago L2 I	2 Months Ago Phase 2 Current	RO	A	32 bit float
850	2 months ago L2 I time	2 Months Ago Phase 2 Current Timestamp	RO	-	32 bit unix time
852	2 months ago L2 Q	2 Months Ago Phase 2 Reactive Power	RO	VAR	32 bit float
854	2 months ago L2 Q time	2 Months Ago Phase 2 Reactive Power Timestamp	RO	-	32 bit unix time
856	2 months ago L2 S	2 Months Ago Phase 2 Apparent Power	RO	VA	32 bit float
858	2 months ago L2 S time	2 Months Ago Phase 2 Apparent Power Timestamp	RO	-	32 bit unix time
860	2 months ago L3 P	2 Months Ago Phase 3 Active Power	RO	W	32 bit float
862	2 months ago L3 P time	2 Months Ago Phase 3 Active Power Timestamp	RO	-	32 bit unix time
864	2 months ago L3 I	2 Months Ago Phase 3 Current	RO	A	32 bit float
866	2 months ago L3 I time	2 Months Ago Phase 3 Current Timestamp	RO	-	32 bit unix time
868	2 months ago L3 Q	2 Months Ago Phase 3 Reactive Power	RO	VAR	32 bit float
870	2 months ago L3 Q time	2 Months Ago Phase 3 Reactive Power Timestamp	RO	-	32 bit unix time
872	2 months ago L3 S	2 Months Ago Phase 3 Apparent Power	RO	VA	32 bit float
874	2 months ago L3 S time	2 Months Ago Phase 3 Apparent Power Timestamp	RO	-	32 bit unix time
876	3 months ago Total P	3 Months Ago Total Active Power	RO	W	32 bit float
878	3 months ago Total P time	3 Months Ago Total Active Power Timestamp	RO	-	32 bit unix time
880	3 months ago Total I	3 Months Ago Total Current	RO	A	32 bit float
882	3 months ago Total I time	3 Months Ago Total Current Timestamp	RO	-	32 bit unix time
884	3 months ago Q top.	3 Months Ago Total Reactive Power	RO	VAR	32 bit float
886	3 months ago Total Q time	3 Months Ago Total Reactive Power Timestamp	RO	-	32 bit unix time
888	3 months ago Total S	3 Months Ago Total Apparent Power	RO	VA	32 bit float
890	3 months ago Total S time	3 Months Ago Total Apparent Power Timestamp	RO	-	32 bit unix time
892	3 months ago L1 P	3 Months Ago Phase 1 Active Power	RO	W	32 bit float
894	3 months ago L1 P time	3 Months Ago Phase 1 Active Power Timestamp	RO	-	32 bit unix time
896	3 months ago L1 I	3 Months Ago Phase 1 Current	RO	A	32 bit float
898	3 months ago L1 I time	3 Months Ago Phase 1 Current Timestamp	RO	-	32 bit unix time
900	3 months ago L1 Q	3 Months Ago Phase 1 Reactive Power	RO	VAR	32 bit float
902	3 months ago L1 Q time	3 Months Ago Phase 1 Reactive Power Timestamp	RO	-	32 bit unix time
904	3 months ago L1 S	3 Months Ago Phase 1 Apparent Power	RO	VA	32 bit float
906	3 months ago L1 S time	3 Months Ago Phase 1 Apparent Power Timestamp	RO	-	32 bit unix time

Address	Parameter	Description	R/W	Unit	Data Type
908	3 months ago L2 P	3 Months Ago Phase 2 Active Power	RO	W	32 bit float
910	3 months ago L2 P time	3 Months Ago Phase 2 Active Power Timestamp	RO	-	32 bit unix time
912	3 months ago L2 I	3 Months Ago Phase 2 Current	RO	A	32 bit float
914	3 months ago L2 I time	3 Months Ago Phase 2 Current Timestamp	RO	-	32 bit unix time
916	3 months ago L2 Q	3 Months Ago Phase 2 Reactive Power	RO	VAr	32 bit float
918	3 months ago L2 Q time	3 Months Ago Phase 2 Reactive Power Timestamp	RO	-	32 bit unix time
920	3 months ago L2 S	3 Months Ago Phase 2 Apparent Power	RO	VA	32 bit float
922	3 months ago L2 S time	3 Months Ago Phase 2 Apparent Power Timestamp	RO	-	32 bit unix time
924	3 months ago L3 P	3 Months Ago Phase 3 Active Power	RO	W	32 bit float
926	3 months ago L3 P time	3 Months Ago Phase 3 Active Power Timestamp	RO	-	32 bit unix time
928	3 months ago L3 I	3 Months Ago Phase 3 Current	RO	A	32 bit float
930	3 months ago L3 I time	3 Months Ago Phase 3 Current Timestamp	RO	-	32 bit unix time
932	3 months ago L3 Q	3 Months Ago Phase 3 Reactive Power	RO	VAr	32 bit float
934	3 months ago L3 Q time	3 Months Ago Phase 3 Reactive Power Timestamp	RO	-	32 bit unix time
936	3 months ago L3 S	3 Months Ago Phase 3 Apparent Power	RO	VA	32 bit float
938	3 months ago L3 S time	3 Months Ago Phase 3 Apparent Power Timestamp	RO	-	32 bit unix time
DI COUNTERS					
940	DI1 Counter	Digital Input1 Counter Value	RO	-	32 bit float
942	DI2 Counter	Digital Input2 Counter Value	RO	-	32 bit float
OTHER					
944	Temp.	Temperature Value	RO	°C	32 bit float
946	Battery Voltage	-	RO	V	32 bit float
948	Time	System Date and Time	R/W	-	32 bit unix time
DI COUNTERS (OPTIONAL DIO MODEL)					
950	DI3 Counter	Digital Input3 Counter Value	RO	-	32 bit float
952	DI4 Counter	Digital Input4 Counter Value	RO	-	32 bit float
954	DI5 Counter	Digital Input5 Counter Value	RO	-	32 bit float
956	DI6 Counter	Digital Input6 Counter Value	RO	-	32 bit float
958	DI7 Counter	Digital Input7 Counter Value	RO	-	32 bit float
ALARM STATUSES					
960	1 - Alarm Timestamp	1 - Alarm time	RO	-	32 bit unix time
962	1 - Alarm ID	1 - Alarm ID	RO	-	32 bit int.
964	1 - Alarm Status	1 - Alarm ON /Alarm OFF status	RO	-	32 bit int.
966	1 - Alarm Value	1 - Value of related alarm parameter	RO	-	32 bit float
968	2 - Alarm Timestamp	2 - Alarm time	RO	-	32 bit unix time
970	2 - Alarm ID	2 - Alarm ID	RO	-	32 bit int.
972	2 - Alarm Status	2 - Alarm ON /Alarm OFF status	RO	-	32 bit int.
974	2 - Alarm Value	2 - Value of related alarm parameter	RO	-	32 bit float
976	3 - Alarm Timestamp	3 - Alarm time	RO	-	32 bit unix time
978	3 - Alarm ID	3 - Alarm ID	RO	-	32 bit int.

Address	Parameter	Description	R/W	Unit	Data Type
980	3 - Alarm Status	3 - Alarm ON /Alarm OFF status	RO	-	32 bit int.
982	3 - Alarm Value	3 - Value of related alarm parameter	RO	-	32 bit float
984	4 - Alarm Timestamp	4 - Alarm time	RO	-	32 bit unix time
986	4 - Alarm ID	4 - Alarm ID	RO	-	32 bit int.
988	4 - Alarm Status	4 - Alarm ON /Alarm OFF status	RO	-	32 bit int.
990	4 - Alarm Value	4 - Value of related alarm parameter	RO	-	32 bit float
992	5 - Alarm Timestamp	5 - Alarm time	RO	-	32 bit unix time
994	5 - Alarm ID	5 - Alarm ID	RO	-	32 bit int.
996	5 - Alarm Status	5 - Alarm ON /Alarm OFF status	RO	-	32 bit int.
998	5 - Alarm Value	5 - Value of related alarm parameter	RO	-	32 bit float
1000	6 - Alarm Timestamp	6 - Alarm time	RO	-	32 bit unix time
1002	6 - Alarm ID	6 - Alarm ID	RO	-	32 bit int.
1004	6 - Alarm Status	6 - Alarm ON /Alarm OFF status	RO	-	32 bit int.
1006	6 - Alarm Value	6 - Value of related alarm parameter	RO	-	32 bit float
1008	7 - Alarm Timestamp	7 - Alarm time	RO	-	32 bit unix time
1010	7 - Alarm ID	7 - Alarm ID	RO	-	32 bit int.
1012	7 - Alarm Status	7 - Alarm ON /Alarm OFF status	RO	-	32 bit int.
1014	7 - Alarm Value	7 - Value of related alarm parameter	RO	-	32 bit float
1016	8 - Alarm Timestamp	8 - Alarm time	RO	-	32 bit unix time
1018	8 - Alarm ID	8 - Alarm ID	RO	-	32 bit int.
1020	8 - Alarm Status	8 - Alarm ON /Alarm OFF status	RO	-	32 bit int.
1022	8 - Alarm Value	8 - Value of related alarm parameter	RO	-	32 bit float
1024	9 - Alarm Timestamp	9 - Alarm time	RO	-	32 bit unix time
1026	9 - Alarm ID	9 - Alarm ID	RO	-	32 bit int.
1028	9 - Alarm Status	9 - Alarm ON /Alarm OFF status	RO	-	32 bit int.
1030	9 - Alarm Value	9 - Value of related alarm parameter	RO	-	32 bit float
1032	10 - Alarm Timestamp	10 - Alarm time	RO	-	32 bit unix time
1034	10 - Alarm ID	10 - Alarm ID	RO	-	32 bit int.
1036	10 - Alarm Status	10 - Alarm ON /Alarm OFF status	RO	-	32 bit int.
1038	10 - Alarm Value	10 - Value of related alarm parameter	RO	-	32 bit float
1040	11 - Alarm Timestamp	11 - Alarm time	RO	-	32 bit unix time
1042	11 - Alarm ID	11 - Alarm ID	RO	-	32 bit int.
1044	11 - Alarm Status	11 - Alarm ON /Alarm OFF status	RO	-	32 bit int.
1046	11 - Alarm Value	11 - Value of related alarm parameter	RO	-	32 bit float
1048	12 - Alarm Timestamp	12 - Alarm time	RO	-	32 bit unix time
1050	12 - Alarm ID	12 - Alarm ID	RO	-	32 bit int.
1052	12 - Alarm Status	12 - Alarm ON /Alarm OFF status	RO	-	32 bit int.
1054	12 - Alarm Value	12 - Value of related alarm parameter	RO	-	32 bit float
1056	13 - Alarm Timestamp	13 - Alarm time	RO	-	32 bit unix time
1058	13 - Alarm ID	13 - Alarm ID	RO	-	32 bit int.
1060	13 - Alarm Status	13 - Alarm ON /Alarm OFF status	RO	-	32 bit int.
1062	13 - Alarm Value	13 - Value of related alarm parameter	RO	-	32 bit float
1064	14 - Alarm Timestamp	14 - Alarm time	RO	-	32 bit unix time
1066	14 - Alarm ID	14 - Alarm ID	RO	-	32 bit int.
1068	14 - Alarm Status	14 - Alarm ON /Alarm OFF status	RO	-	32 bit int.
1070	14 - Alarm Value	14 - Value of related alarm parameter	RO	-	32 bit float

Address	Parameter	Description	R/W	Unit	Data Type
1072	15 - Alarm Timestamp	15 - Alarm time	RO	-	32 bit unix time
1074	15 - Alarm ID	15 - Alarm ID	RO	-	32 bit int.
1076	15 - Alarm Status	15 - Alarm ON /Alarm OFF status	RO	-	32 bit int.
1078	15 - Alarm Value	15 - Value of related alarm parameter	RO	-	32 bit float
1080	16 - Alarm Timestamp	16 - Alarm time	RO	-	32 bit unix time
1082	16 - Alarm ID	16 - Alarm ID	RO	-	32 bit int.
1084	16 - Alarm Status	16 - Alarm ON /Alarm OFF status	RO	-	32 bit int.
1086	16 - Alarm Value	16 - Value of related alarm parameter	RO	-	32 bit float
1088	17 - Alarm Timestamp	17 - Alarm time	RO	-	32 bit unix time
1090	17 - Alarm ID	17 - Alarm ID	RO	-	32 bit int.
1092	17 - Alarm Status	17 - Alarm ON /Alarm OFF status	RO	-	32 bit int.
1094	17 - Alarm Value	17 - Value of related alarm parameter	RO	-	32 bit float
1096	18 - Alarm Timestamp	18 - Alarm time	RO	-	32 bit unix time
1098	18 - Alarm ID	18 - Alarm ID	RO	-	32 bit int.
1100	18 - Alarm Status	18 - Alarm ON /Alarm OFF status	RO	-	32 bit int.
1102	18 - Alarm Value	18 - Value of related alarm parameter	RO	-	32 bit float
1104	19 - Alarm Timestamp	19 - Alarm time	RO	-	32 bit unix time
1106	19 - Alarm ID	19 - Alarm ID	RO	-	32 bit int.
1108	19 - Alarm Status	19 - Alarm ON /Alarm OFF status	RO	-	32 bit int.
1110	19 - Alarm Value	19 - Value of related alarm parameter	RO	-	32 bit float
1112	20 - Alarm Timestamp	20 - Alarm time	RO	-	32 bit unix time
1114	20 - Alarm ID	20 - Alarm ID	RO	-	32 bit int.
1116	20 - Alarm Status	20 - Alarm ON /Alarm OFF status	RO	-	32 bit int.
1118	20 - Alarm Value	20 - Value of related alarm parameter	RO	-	32 bit float
1120	21 - Alarm Timestamp	21 - Alarm time	RO	-	32 bit unix time
1122	21 - Alarm ID	21 - Alarm ID	RO	-	32 bit int.
1124	21 - Alarm Status	21 - Alarm ON /Alarm OFF status	RO	-	32 bit int.
1126	21 - Alarm Value	21 - Value of related alarm parameter	RO	-	32 bit float
1128	22 - Alarm Timestamp	22 - Alarm time	RO	-	32 bit unix time
1130	22 - Alarm ID	22 - Alarm ID	RO	-	32 bit int.
1132	22 - Alarm Status	22 - Alarm ON /Alarm OFF status	RO	-	32 bit int.
1134	22 - Alarm Value	22 - Value of related alarm parameter	RO	-	32 bit float
1136	23 - Alarm Timestamp	23 - Alarm time	RO	-	32 bit unix time
1138	23 - Alarm ID	23 - Alarm ID	RO	-	32 bit int.
1140	23 - Alarm Status	23 - Alarm ON /Alarm OFF status	RO	-	32 bit int.
1142	23 - Alarm Value	23 - Value of related alarm parameter	RO	-	32 bit float
1144	24 - Alarm Timestamp	24 - Alarm time	RO	-	32 bit unix time
1146	24 - Alarm ID	24 - Alarm ID	RO	-	32 bit int.
1148	24 - Alarm Status	24 - Alarm ON /Alarm OFF status	RO	-	32 bit int.
1150	24 - Alarm Value	24 - Value of related alarm parameter	RO	-	32 bit float
1152	25 - Alarm Timestamp	25 - Alarm time	RO	-	32 bit unix time
1154	25 - Alarm ID	25 - Alarm ID	RO	-	32 bit int.
1156	25 - Alarm Status	25 - Alarm ON /Alarm OFF status	RO	-	32 bit int.
1158	25 - Alarm Value	25 - Value of related alarm parameter	RO	-	32 bit float
1160	26 - Alarm Timestamp	26 - Alarm time	RO	-	32 bit unix time
1162	26 - Alarm ID	26 - Alarm ID	RO	-	32 bit int.

Address	Parameter	Description	R/W	Unit	Data Type
1164	26 - Alarm Status	26 - Alarm ON /Alarm OFF status	RO	-	32 bit int.
1166	26 - Alarm Value	26 - Value of related alarm parameter	RO	-	32 bit float
1168	27 - Alarm Timestamp	27 - Alarm time	RO	-	32 bit unix time
1170	27 - Alarm ID	27 - Alarm ID	RO	-	32 bit int.
1172	27 - Alarm Status	27 - Alarm ON /Alarm OFF status	RO	-	32 bit int.
1174	27 - Alarm Value	27 - Value of related alarm parameter	RO	-	32 bit float
1176	28 - Alarm Timestamp	28 - Alarm time	RO	-	32 bit unix time
1178	28 - Alarm ID	28 - Alarm ID	RO	-	32 bit int.
1180	28 - Alarm Status	28 - Alarm ON /Alarm OFF status	RO	-	32 bit int.
1182	28 - Alarm Value	28 - Value of related alarm parameter	RO	-	32 bit float
1184	29 - Alarm Timestamp	29 - Alarm time	RO	-	32 bit unix time
1186	29 - Alarm ID	29 - Alarm ID	RO	-	32 bit int.
1188	29 - Alarm Status	29 - Alarm ON /Alarm OFF status	RO	-	32 bit int.
1190	29 - Alarm Value	29 - Value of related alarm parameter	RO	-	32 bit float
1192	30 - Alarm Timestamp	30 - Alarm time	RO	-	32 bit unix time
1194	30 - Alarm ID	30 - Alarm ID	RO	-	32 bit int.
1196	30 - Alarm Status	30 - Alarm ON /Alarm OFF status	RO	-	32 bit int.
1198	30 - Alarm Value	30 - Value of related alarm parameter	RO	-	32 bit float
1200	31 - Alarm Timestamp	31 - Alarm time	RO	-	32 bit unix time
1202	31 - Alarm ID	31 - Alarm ID	RO	-	32 bit int.
1204	31 - Alarm Status	31 - Alarm ON /Alarm OFF status	RO	-	32 bit int.
1206	31 - Alarm Value	31 - Value of related alarm parameter	RO	-	32 bit float
1208	31 - Alarm Timestamp	32 - Alarm time	RO	-	32 bit unix time
1210	32 - Alarm ID	32 - Alarm ID	RO	-	32 bit int.
1212	32 - Alarm Status	32 - Alarm ON /Alarm OFF status	RO	-	32 bit int.
1214	32 - Alarm Value	32 - Value of related alarm parameter	RO	-	32 bit float
1216	33 - Alarm Timestamp	33 - Alarm time	RO	-	32 bit unix time
1218	33 - Alarm ID	33 - Alarm ID	RO	-	32 bit int.
1220	33 - Alarm Status	33 - Alarm ON /Alarm OFF status	RO	-	32 bit int.
1222	33 - Alarm Value	33 - Value of related alarm parameter	RO	-	32 bit float
1224	34 - Alarm Timestamp	34 - Alarm time	RO	-	32 bit unix time
1226	34 - Alarm ID	34 - Alarm ID	RO	-	32 bit int.
1228	34 - Alarm Status	34 - Alarm ON /Alarm OFF status	RO	-	32 bit int.
1230	34 - Alarm Value	34 - Value of related alarm parameter	RO	-	32 bit float
1232	35 - Alarm Timestamp	35 - Alarm time	RO	-	32 bit unix time
1234	35 - Alarm ID	35 - Alarm ID	RO	-	32 bit int.
1236	35 - Alarm Status	35 - Alarm ON /Alarm OFF status	RO	-	32 bit int.
1238	35 - Alarm Value	35 - Value of related alarm parameter	RO	-	32 bit float
1240	36 - Alarm Timestamp	36 - Alarm time	RO	-	32 bit unix time
1242	36 - Alarm ID	36 - Alarm ID	RO	-	32 bit int.
1244	36 - Alarm Status	36 - Alarm ON /Alarm OFF status	RO	-	32 bit int.
1246	36 - Alarm Value	36 - Value of related alarm parameter	RO	-	32 bit float
1248	37 - Alarm Timestamp	37 - Alarm time	RO	-	32 bit unix time
1250	37 - Alarm ID	37 - Alarm ID	RO	-	32 bit int.
1252	37 - Alarm Status	37 - Alarm ON /Alarm OFF status	RO	-	32 bit int.
1254	37 - Alarm Value	37 - Value of related alarm parameter	RO	-	32 bit float

Address	Parameter	Description	R/W	Unit	Data Type
1256	38 - Alarm Timestamp	38 - Alarm time	RO	-	32 bit unix time
1258	38 - Alarm ID	38 - Alarm ID	RO	-	32 bit int.
1260	38 - Alarm Status	38 - Alarm ON /Alarm OFF status	RO	-	32 bit int.
1262	38 - Alarm Value	38 - Value of related alarm parameter	RO	-	32 bit float
1264	39 - Alarm Timestamp	39 - Alarm time	RO	-	32 bit unix time
1266	39 - Alarm ID	39 - Alarm ID	RO	-	32 bit int.
1268	39 - Alarm Status	39 - Alarm ON /Alarm OFF status	RO	-	32 bit int.
1270	39 - Alarm Value	39 - Value of related alarm parameter	RO	-	32 bit float
1272	40 - Alarm Timestamp	40 - Alarm time	RO	-	32 bit unix time
1274	40 - Alarm ID	40 - Alarm ID	RO	-	32 bit int.
1276	40 - Alarm Status	40 - Alarm ON /Alarm OFF status	RO	-	32 bit int.
1278	40 - Alarm Value	40 - Value of related alarm parameter	RO	-	32 bit float
1280	41 - Alarm Timestamp	41 - Alarm time	RO	-	32 bit unix time
1282	41 - Alarm ID	41 - Alarm ID	RO	-	32 bit int.
1284	41 - Alarm Status	41 - Alarm ON /Alarm OFF status	RO	-	32 bit int.
1286	41 - Alarm Value	41 - Value of related alarm parameter	RO	-	32 bit float
1288	42 - Alarm Timestamp	42 - Alarm time	RO	-	32 bit unix time
1290	42 - Alarm ID	42 - Alarm ID	RO	-	32 bit int.
1292	42 - Alarm Status	42 - Alarm ON /Alarm OFF status	RO	-	32 bit int.
1294	42 - Alarm Value	42 - Value of related alarm parameter	RO	-	32 bit float
1296	43 - Alarm Timestamp	43 - Alarm time	RO	-	32 bit unix time
1298	43 - Alarm ID	43 - Alarm ID	RO	-	32 bit int.
1300	43 - Alarm Status	43 - Alarm ON /Alarm OFF status	RO	-	32 bit int.
1302	43 - Alarm Value	43 - Value of related alarm parameter	RO	-	32 bit float
1304	44 - Alarm Timestamp	44 - Alarm time	RO	-	32 bit unix time
1306	44 - Alarm ID	44 - Alarm ID	RO	-	32 bit int.
1308	44 - Alarm Status	44 - Alarm ON /Alarm OFF status	RO	-	32 bit int.
1310	44 - Alarm Value	44 - Value of related alarm parameter	RO	-	32 bit float
1312	45 - Alarm Timestamp	45 - Alarm time	RO	-	32 bit unix time
1314	45 - Alarm ID	45 - Alarm ID	RO	-	32 bit int.
1316	45 - Alarm Status	45 - Alarm ON /Alarm OFF status	RO	-	32 bit int.
1318	45 - Alarm Value	45 - Value of related alarm parameter	RO	-	32 bit float
1320	46 - Alarm Timestamp	46 - Alarm time	RO	-	32 bit unix time
1322	46 - Alarm ID	46 - Alarm ID	RO	-	32 bit int.
1324	46 - Alarm Status	46 - Alarm ON /Alarm OFF status	RO	-	32 bit int.
1326	46 - Alarm Value	46 - Value of related alarm parameter	RO	-	32 bit float
1328	47 - Alarm Timestamp	47 - Alarm time	RO	-	32 bit unix time
1330	47 - Alarm ID	47 - Alarm ID	RO	-	32 bit int.
1332	47 - Alarm Status	47 - Alarm ON /Alarm OFF status	RO	-	32 bit int.
1334	47 - Alarm Value	47 - Value of related alarm parameter	RO	-	32 bit float
1336	48 - Alarm Timestamp	48 - Alarm time	RO	-	32 bit unix time
1338	48 - Alarm ID	48 - Alarm ID	RO	-	32 bit int.
1340	48 - Alarm Status	48 - Alarm ON /Alarm OFF status	RO	-	32 bit int.
1342	48 - Alarm Value	48 - Value of related alarm parameter	RO	-	32 bit float
1344	49 - Alarm Timestamp	49 - Alarm time	RO	-	32 bit unix time
1346	49 - Alarm ID	49 - Alarm ID	RO	-	32 bit int.
1348	49 - Alarm Status	49 - Alarm ON /Alarm OFF status	RO	-	32 bit int.

Address	Parameter	Description	R/W	Unit	Data Type
1350	49 - Alarm Value	49 - Value of related alarm parameter	RO	-	32 bit float
1352	50 - Alarm Timestamp	50 - Alarm time	RO	-	32 bit unix time
1354	50 - Alarm ID	50 - Alarm ID	RO	-	32 bit int.
1356	50 - Alarm Status	50 - Alarm ON /Alarm OFF status	RO	-	32 bit int.
1358	50 - Alarm Value	50 - Value of related alarm parameter	RO	-	32 bit float
LAST SAVED FILE NUMBERS					
1360	Hourly Archival File Nr.	Latest recorded hourly archival file number	RO	-	32 bit int.
1362	Daily Archival File Nr.	Latest recorded daily archival file number	RO	-	32 bit int.
1364	Monthly Archival File Nr.	Latest recorded monthly archival file number	RO	-	32 bit int.
TARIFF METERS (64 bit)					
1366	T1 Imp. Active Index	Tariff 1 Import Active Index	RO	kWh	64 bit double
1370	T1_1 Imp. Active Index	T1 Rate 1 Import Active Index	RO	kWh	64 bit double
1374	T1_2 Imp. Active Index	T1 Rate 2 Import Active Index	RO	kWh	64 bit double
1378	T1_3 Imp. Active Index	T1 Rate 3 Import Active Index	RO	kWh	64 bit double
1382	T2 Imp. Active Index	Tariff 2 Import Active Index	RO	kWh	64 bit double
1386	T1 Exp. Active Index	Tariff 1 Export Active Index	RO	kWh	64 bit double
1390	T1_1 Exp. Active Index	T1 Rate 1 Export Active Index	RO	kWh	64 bit double
1394	T1_2 Exp. Active Index	T1 Rate 2 Export Active Index	RO	kWh	64 bit double
1398	T1_3 Exp. Active Index	T1 Rate 3 Export Active Index	RO	kWh	64 bit double
1402	T2 Exp. Active Index	Tariff 2 Export Active Index	RO	kWh	64 bit double
1406	T1 Imp. Reactive Index	Tariff 1 Import Reactive Index	RO	kWh	64 bit double
1410	T1_1 Imp. Reactive Index	T1 Rate 1 Import Reactive Index	RO	kWh	64 bit double
1414	T1_2 Imp. Reactive Index	T1 Rate 2 Import Reactive Index	RO	kWh	64 bit double
1418	T1_3 Imp. Reactive Index	T1 Rate 3 Import Reactive Index	RO	kWh	64 bit double
1422	T2 Imp. Reactive Index	Tariff 2 Import Reactive Index	RO	kWh	64 bit double
1426	T1 Exp. Reactive Index	Tariff 1 Export Active Index	RO	kWh	64 bit double
1430	T1_1 Exp. Reactive Index	T1 Rate 1 Export Reactive Index	RO	kWh	64 bit double
1434	T1_2 Exp. Reactive Index	T1 Rate 2 Export Reactive Index	RO	kWh	64 bit double
1438	T1_3 Exp. Reactive Index	T1 Rate 3 Export Reactive Index	RO	kWh	64 bit double
1442	T2 Exp. Reactive Index	Tariff 2 Export Reactive Index	RO	kWh	64 bit double
DI FLAGS					
1446	Digital Input Flags	Digital Input Active/Passive Flags	RO	kWh	32 bit int.
OTHER COUNTERS					
1448	Run Hour Counter	Run Hour Counter	RO	h	32 bit integer
1450	On Hour Counter	On Hour Counter	RO	h	32 bit integer
1452	Power Interruption Counter	Power Interruption Counter	RO	-	32 bit integer
1454	Total Run minute counter	Total Run minute counter	RO	min.	32 bit integer
1456	Total On minute counter	Total On minute counter	RO	min.	32 bit integer
PHASE ENERGIES (DOUBLE)					
1458	Phase R Import Active Energy T1	T1 Rate Phase R Import Active Energy	RO	kWh	64 bit double
1462	Phase R Import Active Energy T1_1	T1_1 Rate Phase R Import Active Energy	RO	kWh	64 bit double
1466	Phase R Import Active Energy T1_2	T1_2 Rate Phase R Import Active Energy	RO	kWh	64 bit double
1470	Phase R Import Active Energy T1_3	T1_3 Rate Phase R Import Active Energy	RO	kWh	64 bit double
1474	Phase R Import Active Energy T2	T2 Rate Phase R Import Active Energy	RO	kWh	64 bit double
1478	Phase S Import Active Energy T1	T1_1 Rate Phase S Import Active Energy	RO	kWh	64 bit double
1482	Phase S Import Active Energy T1_1	T1_2 Rate Phase S Import Active Energy	RO	kWh	64 bit double

Address	Parameter	Description	R/W	Unit	Data Type
1486	Phase S Import Active Energy T1_2	T1_2 Rate Phase S Import Active Energy	RO	kWh	64 bit double
1490	Phase S Import Active Energy T1_3	T1_3 Rate Phase S Import Active Energy	RO	kWh	64 bit double
1494	Phase S Import Active Energy T2	T2 Rate Phase S Import Active Energy	RO	kWh	64 bit double
1498	Phase T Import Active Energy T1	T1 Rate Phase T Import Active Energy	RO	kWh	64 bit double
1502	Phase T Import Active Energy T1_1	T1_1 Rate Phase T Import Active Energy	RO	kWh	64 bit double
1506	Phase T Import Active Energy T1_2	T1_2 Rate Phase T Import Active Energy	RO	kWh	64 bit double
1510	Phase T Import Active Energy T1_3	T1_3 Rate Phase T Import Active Energy	RO	kWh	64 bit double
1514	Phase T Import Active Energy T2	T2 Rate Phase T Import Active Energy	RO	kWh	64 bit double
1518	Phase R Export Active Energy T1	T1 Rate Phase R Export Active Energy	RO	kWh	64 bit double
1522	Phase R Export Active Energy T1_1	T1_1 Rate Phase R Export Active Energy	RO	kWh	64 bit double
1526	Phase R Export Active Energy T1_2	T1_2 Rate Phase R Export Active Energy	RO	kWh	64 bit double
1530	Phase R Export Active Energy T1_3	T1_3 Rate Phase R ExportActive Energy	RO	kWh	64 bit double
1534	Phase R Export Active Energy T2	T2 Rate Phase R ExportActive Energy	RO	kWh	64 bit double
1538	Phase S Export Active Energy T1	T1 Rate Phase S Export Active Energy	RO	kWh	64 bit double
1542	Phase S Export Active Energy T1_1	T1_1 Rate Phase S ExportActive Energy	RO	kWh	64 bit double
1546	Phase S Export Active Energy T1_2	T1_2 Rate Phase S Export Active Energy	RO	kWh	64 bit double
1550	Phase S Export Active Energy T1_3	T1_3 Rate Phase S Export Active Energy	RO	kWh	64 bit double
1554	Phase S Export Active Energy T2	T2 Rate Phase S ExportActive Energy	RO	kWh	64 bit double
1558	Phase T Export Active Energy T1	T1 Rate Phase T Export Active Energy	RO	kWh	64 bit double
1562	Phase T Export Active Energy T1_1	T1_1 Rate Phase T Export Active Energy	RO	kWh	64 bit double
1566	Phase T Export Active Energy T1_2	T1_2 Rate Phase T Export Active Energy	RO	kWh	64 bit double
1570	Phase T Export Active Energy T1_3	T1_3 Rate Phase T Export Active Energy	RO	kWh	64 bit double
1574	Phase T Export Active Energy T2	T2 Rate Phase T Export Active Energy	RO	kWh	64 bit double
1578	Phase R Import Reactive Energy T1	T1 Rate Phase R Import Reactive Energy	RO	kVArh	64 bit double
1582	Phase R Import Reactive Energy T1_1	T1_1 Rate Phase R Import Reactive Energy	RO	kVArh	64 bit double
1586	Phase R Import Reactive Energy T1_2	T1_2 Rate Phase R Import Reactive Energy	RO	kVArh	64 bit double
1590	Phase R Import Reactive Energy T1_3	T1_3 Rate Phase R Import Reactive Energy	RO	kVArh	64 bit double
1594	Phase R Import Reactive Energy T2	T2 Rate Phase R Import Reactive Energy	RO	kVArh	64 bit double
1598	Phase S Import Reactive Energy T1	T1 Rate Phase S Import Reactive Energy	RO	kVArh	64 bit double
1602	Phase S Import Reactive Energy T1_1	T1_1 Rate Phase S Import Reactive Energy	RO	kVArh	64 bit double
1606	Phase S Import Reactive Energy T1_2	T1_2 Rate Phase S Import Reactive Energy	RO	kVArh	64 bit double
1610	Phase S Import Reactive Energy T1_3	T1_3 Rate Phase S Import Reactive Energy	RO	kVArh	64 bit double
1614	Phase S Import Reactive Energy T2	T2 Rate Phase S Import Reactive Energy	RO	kVArh	64 bit double
1618	Phase T Import Reactive Energy T1	T1 Rate Phase T Import Reactive Energy	RO	kVArh	64 bit double
1622	Phase T Import Reactive Energy T1_1	T1_1 Rate Phase T Import Reactive Energy	RO	kVArh	64 bit double
1626	Phase T Import Reactive Energy T1_2	T1_2 Rate Phase T Import ReactiveEnergy	RO	kVArh	64 bit double
1630	Phase T Import Reactive Energy T1_3	T1_3 Rate Phase T Import Reactive Energy	RO	kVArh	64 bit double
1634	Phase T Import Reactive Energy T2	T2 Rate Phase T Import Reactive Energy	RO	kVArh	64 bit double
1638	Phase R Export Reactive Energy T1	T1 Rate Phase R Export Reactive Energy	RO	kVArh	64 bit double
1642	Phase R Export Reactive Energy T1_1	T1_1 Rate Phase R Export Reactive Energy	RO	kVArh	64 bit double
1646	Phase R Export Reactive Energy T1_2	T1_2 Rate Phase R Export Reactive Energy	RO	kVArh	64 bit double
1650	Phase R Export Reactive Energy T1_3	T1_3 Rate Phase R Export Reactive Energy	RO	kVArh	64 bit double
1654	Phase R Export Reactive Energy T2	T2 Rate Phase R Export Reactive Energy	RO	kVArh	64 bit double
1658	Phase S Export Reactive Energy T1	T1_1 Rate Phase S Export Reactive Energy	RO	kVArh	64 bit double
1662	Phase S Export Reactive Energy T1_1	T1_2 Rate Phase S Export Reactive Energy	RO	kVArh	64 bit double
1666	Phase S Export Reactive Energy T1_2	T1_3 Rate Phase S Export Reactive Energy	RO	kVArh	64 bit double
1670	Phase S Export Reactive Energy T1_3	T1_3 Rate Phase S Export Reactive Energy	RO	kVArh	64 bit double

Address	Parameter	Description	R/W	Unit	Data Type
1674	Faz S T2 Ür. Reaktif Endeks	Faz S Tarife2 Üretilen Reaktif Endeks	RO	kVArh	64 bit double
1678	Faz T T1 Ür. Reaktif Endeks	Faz T Tarife1 Üretilen Reaktif Endeks	RO	kVArh	64 bit double
1682	Faz T T1_1 Ür. Reaktif Endeks	Faz T Tarife1_1 Üretilen Reaktif Endeks	RO	kVArh	64 bit double
1686	Faz T T1_2 Ür. Reaktif Endeks	Faz T Tarife1_2 Üretilen Reaktif Endeks	RO	kVArh	64 bit double
1690	Faz T T1_3 Ür. Reaktif Endeks	Faz T Tarife1_3 Üretilen Reaktif Endeks	RO	kVArh	64 bit double
1694	Faz T T2 Ür. Reaktif Endeks	Faz T Tarife2 Üretilen Reaktif Endeks	RO	kVArh	64 bit double
DIGITAL OUTPUT LOGS					
1698	Log 1 Time stamp	Log 1 Time stamp	RO	-	32 bit time_t (unix time)
1700	Log 1 Data	Log 1 Data	RO	-	32 bit integer
1702	Log 2 Time stamp	Log 2 Time stamp	RO	-	32 bit time_t (unix time)
1704	Log 2 Data	Log 2 Data	RO	-	32 bit integer
1706	Log 3 Time stamp	Log 3 Time stamp	RO	-	32 bit time_t (unix time)
1708	Log 3 Data	Log 3 Data	RO	-	32 bit integer
1710	Log 4 Time stamp	Log 4 Time stamp	RO	-	32 bit time_t (unix time)
1712	Log 4 Data	Log 4 Data	RO	-	32 bit integer
1714	Log 5 Time stamp	Log 5 Time stamp	RO	-	32 bit time_t (unix time)
1716	Log 5 Data	Log 5 Data	RO	-	32 bit integer
1718	Log 6 Time stamp	Log 6 Time stamp	RO	-	32 bit time_t (unix time)
1720	Log 6 Data	Log 6 Data	RO	-	32 bit integer
1722	Log 7 Time stamp	Log 7 Time stamp	RO	-	32 bit time_t (unix time)
1724	Log 7 Data	Log 7 Data	RO	-	32 bit integer
1726	Log 8 Time stamp	Log 8 Time stamp	RO	-	32 bit time_t (unix time)
1728	Log 8 Data	Log 8 Data	RO	-	32 bit integer
1730	Log 9 Time stamp	Log 9 Time stamp	RO	-	32 bit time_t (unix time)
1732	Log 9 Data	Log 9 Data	RO	-	32 bit integer
1734	Log 10 Time stamp	Log 10 Time stamp	RO	-	32 bit time_t (unix time)
1736	Log 10 Data	Log 10 Data	RO	-	32 bit integer
1738	Log 11 Time stamp	Log 11 Time stamp	RO	-	32 bit time_t (unix time)
1740	Log 11 Data	Log 11 Data	RO	-	32 bit integer
1742	Log 12 Time stamp	Log 12 Time stamp	RO	-	32 bit time_t (unix time)
1744	Log 12 Data	Log 12 Data	RO	-	32 bit integer
1746	Log 13 Time stamp	Log 13 Time stamp	RO	-	32 bit time_t (unix time)
1748	Log 13 Data	Log 13 Data	RO	-	32 bit integer
1750	Log 14 Time stamp	Log 14 Time stamp	RO	-	32 bit time_t (unix time)
1752	Log 14 Data	Log 14 Data	RO	-	32 bit integer
1754	Log 15 Time stamp	Log 15 Time stamp	RO	-	32 bit time_t (unix time)
1756	Log 15 Data	Log 15 Data	RO	-	32 bit integer

Address	Parameter	Description	R/W	Unit	Data Type
1758	Log 16 Time stamp	Log 16 Time stamp	RO	-	32 bit time_t (unix time)
1760	Log 16 Data	Log 16 Data	RO	-	32 bit integer
1762	Log 17 Time stamp	Log 17 Time stamp	RO	-	32 bit time_t (unix time)
1764	Log 17 Data	Log 17 Data	RO	-	32 bit integer
1766	Log 18 Time stamp	Log 18 Time stamp	RO	-	32 bit time_t (unix time)
1768	Log 18 Data	Log 18 Data	RO	-	32 bit integer
1770	Log 19 Time stamp	Log 19 Time stamp	RO	-	32 bit time_t (unix time)
1772	Log 19 Data	Log 19 Data	RO	-	32 bit integer
1774	Log 20 Time stamp	Log 20 Time stamp	RO	-	32 bit time_t (unix time)
1776	Log 20 Data	Log 20 Data	RO	-	32 bit integer
1778	Log 21 Time stamp	Log 21 Time stamp	RO	-	32 bit time_t (unix time)
1780	Log 21 Data	Log 21 Data	RO	-	32 bit integer
1782	Log 22 Time stamp	Log 22 Time stamp	RO	-	32 bit time_t (unix time)
1784	Log 22 Data	Log 22 Data	RO	-	32 bit integer
1786	Log 23 Time stamp	Log 23 Time stamp	RO	-	32 bit time_t (unix time)
1788	Log 23 Data	Log 23 Data	RO	-	32 bit integer
1790	Log 24 Time stamp	Log 24 Time stamp	RO	-	32 bit time_t (unix time)
1792	Log 24 Data	Log 24 Data	RO	-	32 bit integer
1794	Log 25 Time stamp	Log 25 Time stamp	RO	-	32 bit time_t (unix time)
1796	Log 25 Data	Log 25 Data	RO	-	32 bit integer
1798	Log 26 Time stamp	Log 26 Time stamp	RO	-	32 bit time_t (unix time)
1800	Log 26 Data	Log 26 Data	RO	-	32 bit integer
1802	Log 27 Time stamp	Log 27 Time stamp	RO	-	32 bit time_t (unix time)
1804	Log 27 Data	Log 27 Data	RO	-	32 bit integer
1806	Log 28 Time stamp	Log 28 Time stamp	RO	-	32 bit time_t (unix time)
1808	Log 28 Data	Log 28 Data	RO	-	32 bit integer
PHASE ENERGIES (DOUBLE)					
1810	DI energy 1	1st counter activated by digital input 1	RO	kWh	64 bit double
1814	DI energy 2	2nd counter activated by digital input 2	RO	kWh	64 bit double
1818	DI energy 3	3rd counter activated by digital input 3	RO	kWh	64 bit double
1822	DI energy 4	4th counter activated by digital input 4	RO	kWh	64 bit double
1826	DI energy 5	5th counter activated by digital input 5	RO	kWh	64 bit double
1830	DI energy 6	6th counter activated by digital input 6	RO	kWh	64 bit double
1834	DI energy 7	7th counter activated by digital input 7	RO	kWh	64 bit double

NOTE: Tariff Meters Index Values can be read in 32 bit and/or 64 bit floating point format. Mathematically, 64 bit floating point representation is more accurate than 32bit floating point format.

e.g.: When it is required to read “Tariff 1 Import Active Index” value, it can be received either 32 bit floating point format (register 404, 405) or in 64 bit floating point format (registers 1366, 1367, 1368, 1369)

Unix Time: Unix time is the number of seconds elapsed since midnight (00:00) Coordinated Universal Time (UTC) of January 1, 1970, not counting leaps seconds.

4.5.1.1 Alarm Flags

Each bit of an alarm flag variable corresponds to ‘one’ alarm flag.

If any bit’s value is “1”, then there is alarm for that bit. On the contrary, a bit value of “1” means that there is NO alarm for that bit.

The contents of alarm flag variables are listed below.

Alarms 1

b7 THDV1	b6 I3	b5 I2	b4 I1	b3 V3	b2 V2	b1 V1	b0 Sic.
b15 VLL2	b14 VLL1	b13 -	b12 V3 Harmonics	b11 V2 Harmonics	b10 V1 Harmonics	b9 THDV3	b8 THDV2
b23 Q3	b22 Q2	b21 Q1	b20 P3	b19 P2	b18 P1	b17 IN	b16 VLL3
b31 PF2	b30 PF1	b29 CosØ3	b28 CosØ2	b27 CosØ1	b26 S3	b25 S2	b24 S1

Alarms 2

b7 I1 Harmonics	b6 THDI3	b5 THDI2	b4 THDI1	b3 F3	b2 F2	b1 F1	b0 PF3
b15 -	b14 -	b13 -	b12 -	b11 Battery Voltage	b10 -	b9 I3 Harmonics	b8 I2 Harmonics
b23 -	b22 -	b21 -	b20 -	b19 -	b18 -	b17 -	b16 -
b31 -	b30 -	b29 -	b28 -	b27 -	b26 -	b25 -	b24 -

4.5.1.2 Digital Input Flags

In order to understand related digital input active or passive, user should query 1446th modbus address. If related digital input is active(shorted with GND), the reading value will be “1” otherwise “0”.

e.g.

Assume that, 1146th modbus address is being queried;

if bit1 equals 1 => it means, DI2 and GND are short circuit in that moment.

if bit1 equals 0 => it means, DI2 and GND are open circuit in that moment.

DI Flags

<u>bit 31</u>	<u>bit 30</u>	<u>bit 29</u>	<u>bit 28</u>	<u>bit 27</u>	<u>bit 26</u>	<u>bit 25</u>	<u>bit 24</u>
-	-	-	-	-	-	-	-
<u>bit 23</u>	<u>bit 22</u>	<u>bit 21</u>	<u>bit 20</u>	<u>bit 19</u>	<u>bit 18</u>	<u>bit 17</u>	<u>bit 16</u>
-	-	-	-	-	-	-	-
<u>bit 15</u>	<u>bit 14</u>	<u>bit 13</u>	<u>bit 12</u>	<u>bit 11</u>	<u>bit 10</u>	<u>bit 9</u>	<u>bit 8</u>
-	-	-	-	-	-	-	-
<u>bit 7</u>	<u>bit 6</u>	<u>bit 5</u>	<u>bit 4</u>	<u>bit 3</u>	<u>bit 2</u>	<u>bit 1</u>	<u>bit 0</u>
-	DI 7	DI 6	DI 5	DI 4	DI 3	DI 2	DI 1

Abbreviations used for the Alarm Flags are:

Temp.	:	Temperature
V1	:	Phase1 (L-N) Voltage
V2	:	Phase2 (L-N) Voltage
V3	:	Phase3 (L-N) Voltage
I1	:	Phase1 Current
I2	:	Phase2 Current
I3	:	Phase3 Current
THDV1	:	Phase1 Total Harmonic Distortion in Voltage
THDV2	:	Phase2 Total Harmonic Distortion in Voltage
THDV3	:	Phase3 Total Harmonic Distortion in Voltage
V1 Harmonics	:	Phase1 Voltage Harmonics
V2 Harmonics	:	Phase2 Voltage Harmonics
V3 Harmonics	:	Phase3 Voltage Harmonics
VLL1	:	Phase1-Phase2 Voltage
VLL2	:	Phase2-Phase3 Voltage
VLL3	:	Phase3-Phase1 Voltage
IN	:	Neutral Current
P1	:	Phase1 Active Power
P2	:	Phase2 Active Power
P3	:	Phase3 Active Power
Q1	:	Phase1 Reactive Power
Q2	:	Phase2 Reactive Power
Q3	:	Phase3 Reactive Power
S1	:	Phase1 Apparent Power
S2	:	Phase2 Apparent Power
S3	:	Phase3 Apparent Power
CosØ1	:	Phase1 CosØ
CosØ2	:	Phase2 CosØ
CosØ3	:	Phase3 CosØ
PF1	:	Phase1 Power Factor
PF2	:	Phase2 Power Factor
PF3	:	Phase3 Power Factor
F1	:	Phase1 Frequency
F2	:	Phase2 Frequency
F3	:	Phase3 Frequency
THDI1	:	Phase1 Total Harmonic Distortion in Current
THDI2	:	Phase2 Total Harmonic Distortion in Current
THDI3	:	Phase3 Total Harmonic Distortion in Current
I1 Harmonics	:	Phase1 Current Harmonics
I2 Harmonics	:	Phase2 Current Harmonics
I3 Harmonics	:	Phase3 Current Harmonics



4.5.2 KLEA Setting Parameters

Operator/programmer should use '10H - Write Multiple Registers and '06H - Write Single Register' to change settings parameters.

Operator/programmer should use '0x3H - Read Holding Registers' function to read setting parameters.

1 register -> comprises of 2 bytes.



After Klea setting parameters have been changed, in order for the new values to be saved in non-volatile memory; 0x0000 should be written to register 1998, and 0x0001 should be written in register 1999, within 60 seconds following the last setting change. Only after that, changes will be stored in the permanent memory.

NOTE1:

3 parameters given with "RO (Read Only)" in Table 4-5 are read-only data. They cannot be changed by the user. This data is as given below:

- Serial Number
- Firmware Version
- Compiler Version

NOTE2:

1998 addressed variable at the end of [Table 4-5](#) is a "W (only writable)" variable.

Table 4-5 Setting Parameters

Address	Parameter	Data Type	Description	R/W	Unit	Low Limit	High Limit
NETWORK SETTINGS							
2000	Current Transf. Ratio (CTR)	32 bit float	-	R/W	-	1	5000
2002	Voltage Transf. Ratio (VTR)	32 bit float	-	R/W	-	1	5000
2004	Connection	32 bit int.	SL1	R/W	-	0	2
2006	Demand Period	32 bit int.	-	R/W	min.	1	60
2008	Power Unit	32 bit int.	SL2	R/W	-	0	1
ENERGY SETTINGS							
2010	T1_1 Start Time	32 bit int.	-	R/W	hour	0	23
2012	T1_2 Start Time	32 bit int.	-	R/W	hour	0	23
2014	T1_3 Start Time	32 bit int.	-	R/W	hour	0	23
2016	Start of day	32 bit int.	-	R/W	hour	0	23
2018	Start of month	32 bit int.	-	R/W	-	1	28
2020	T1 kWh	32 bit float	-	R/W	kWh	0	20000000000.0
2022	T1 kWh E.	32 bit float	-	R/W	kWh	0	20000000000.0

Address	Parameter	Data Type	Description	R/W	Unit	Low Limit	High Limit
2024	T1 kVArh I.	32 bit float	-	R/W	kVArh	0	20000000000.0
2026	T1 kVArh E.	32 bit float	-	R/W	kVArh	0	20000000000.0
2028	T1_1 kWh	32 bit float	-	R/W	kWh	0	20000000000.0
2030	T1_1 kWh E.	32 bit float	-	R/W	kWh	0	20000000000.0
2032	T1_1 kVArh I.	32 bit float	-	R/W	kVArh	0	20000000000.0
2034	T1_1 kVArh E.	32 bit float	-	R/W	kVArh	0	20000000000.0
2036	T1_2 kWh	32 bit float	-	R/W	kWh	0	20000000000.0
2038	T1_2 kWh E.	32 bit float	-	R/W	kWh	0	20000000000.0
2040	T1_2 kVArh I.	32 bit float	-	R/W	kVArh	0	20000000000.0
2042	T1_2 kVArh E.	32 bit float	-	R/W	kVArh	0	20000000000.0
2044	T1_3 kWh	32 bit float	-	R/W	kWh	0	20000000000.0
2046	T1_3 kWh E.	32 bit float	-	R/W	kWh	0	20000000000.0
2048	T1_3 kVArh I.	32 bit float	-	R/W	kVArh	0	20000000000.0
2050	T1_3 kVArh E.	32 bit float	-	R/W	kVArh	0	20000000000.0
2052	T2 kWh	32 bit float	-	R/W	kWh	0	20000000000.0
2054	T2 kWh E.	32 bit float	-	R/W	kWh	0	20000000000.0
2056	T2 kVArh I.	32 bit float	-	R/W	kVArh	0	20000000000.0
2058	T2 kVArh E.	32 bit float	-	R/W	kVArh	0	20000000000.0
DIGITAL OUTPUT SETTINGS							
2060	Output1 Mode	32 bit int.	SL3	R/W	-	0	21
2062	Output1 Energy	32 bit float	-	R/W	-	0.001	10000000000
2064	Output1 Width	32 bit int.	-	R/W	msec.	50	2500
2066	Output1 Multiplier	32 bit int.	-	R/W	-	1	10000
2068	Output2 Mode	32 bit int.	SL3	R/W	-	0	21
2070	Output2 Energy	32 bit float	-	R/W	-	0.001	10000000000
2072	Output2 Width	32 bit int.	-	R/W	msec.	50	2500
2074	Output2 Multiplier	32 bit int.	-	R/W	-	1	10000
DIGITAL INPUT SETTINGS							
2076	Input1 Mode	32 bit int.	SL4	R/W	-	0	2
2078	Input1 Delay	32 bit int.	-	R/W	msec	10	2000
2080	Input2 Mode	32 bit int.	SL4	R/W	-	0	2
2082	Input2 Delay	32 bit int.	-	R/W	msec	10	2000
COMMUNICATION							
2084	Baud Rate	32 bit int.	SL5	R/W	-	0	6
2086	Slave Id	32 bit int.	-	R/W	-	1	247
ALARMS							
VOLTAGE (L-N) ALARM							
2088	Alarm Relay	32 bit int.	SL6	R/W	-	0	2
2090	Low Limit	32 bit float	-	R/W	V	0	1500000
2092	High Limit	32 bit float	-	R/W	V	0	1500000
2094	Delay	32 bit int.	-	R/W	sec	0	600
2096	Hysteresis	32 bit float	-	R/W	%	0	20

Address	Parameter	Data Type	Description	R/W	Unit	Low Limit	High Limit
VOLTAGE (L-L) ALARM							
2098	Alarm Relay	32 bit int.	SL6	R/W	-	0	2
2100	Low Limit	32 bit float	-	R/W	V	0	2600000
2102	High Limit	32 bit float	-	R/W	V	0	2600000
2104	Delay	32 bit int.	-	R/W	sec	0	600
2106	Hysteresis	32 bit float	-	R/W	%	0	20
CURRENT ALARM							
2108	Alarm Relay	32 bit int.	SL6	R/W	-	0	2
2110	Low Limit	32 bit float	-	R/W	A	0	30000
2112	High Limit	32 bit float	-	R/W	A	0	30000
2114	Delay	32 bit int.	-	R/W	sec	0	600
2116	Hysteresis	32 bit float	-	R/W	%	0	20
ACTIVE POWER ALARM							
2118	Alarm Relay	32 bit int.	SL6	R/W	-	0	2
2120	Low Limit	32 bit float	-	R/W	W	-1,00E+10	1,00E+10
2122	High Limit	32 bit float	-	R/W	W	-1,00E+10	1,00E+10
2124	Delay	32 bit int.	-	R/W	sec	0	600
2126	Hysteresis	32 bit float	-	R/W	%	0	20
REACTIVE POWER ALARM							
2128	Alarm Relay	32 bit int.	SL6	R/W	-	0	2
2130	Low Limit	32 bit float	-	R/W	VAr	-1,00E+10	1,00E+10
2132	High Limit	32 bit float	-	R/W	VAr	-1,00E+10	1,00E+10
2134	Delay	32 bit int.	-	R/W	sec	0	600
2136	Hysteresis	32 bit float	-	R/W	%	0	20
APPARENT POWER ALARM							
2138	Alarm Relay	32 bit int.	SL6	R/W	-	0	2
2140	Low Limit	32 bit float	-	R/W	VA	0	1,00E+10
2142	High Limit	32 bit float	-	R/W	VA	0	1,00E+10
2144	Delay	32 bit int.	-	R/W	sec	0	600
2146	Hysteresis	32 bit float	-	R/W	%	0	20
NEUTRAL CURRENT ALARM							
2148	Alarm Relay	32 bit int.	SL6	R/W	-	0	2
2150	Low Limit	32 bit float	-	R/W	A	0	30000
2152	High Limit	32 bit float	-	R/W	A	0	30000
2154	Delay	32 bit int.	-	R/W	sec	0	600
2156	Hysteresis	32 bit float	-	R/W	%	0	20
POWER FACTOR ALARM							
2158	Alarm Relay	32 bit int.	SL6	R/W	-	0	2
2160	Low Limit	32 bit float	-	R/W	-	0	1
2162	High Limit	32 bit float	-	R/W	-	0	1
2164	Delay	32 bit int.	-	R/W	sn	0	600
2166	Hysteresis	32 bit float	-	R/W	%	0	20
COSØ ALARM							
2168	Alarm Relay	32 bit int.	SL6	R/W	-	0	2
2170	Low Limit	32 bit float	-	R/W	-	0	1

Address	Parameter	Data Type	Description	R/W	Unit	Low Limit	High Limit
2172	High Limit	32 bit float	-	R/W	-	0	1
2174	Delay	32 bit int.	-	R/W	sec	0	600
2176	Hysteresis	32 bit float	-	R/W	%	0	20
FREQUENCY ALARM							
2178	Alarm Relay	32 bit int.	SL6	R/W	-	0	2
2180	Low Limit	32 bit float	-	R/W	Hz	35	70
2182	High Limit	32 bit float	-	R/W	Hz	35	70
2184	Delay	32 bit int.	-	R/W	sec	0	600
2186	Hysteresis	32 bit float	-	R/W	%	0	20
TEMPERATURE ALARM							
2188	Alarm Relay	32 bit int.	SL6	R/W	-	0	2
2190	Low Limit	32 bit float	-	R/W	°C	-20	80
2192	High Limit	32 bit float	-	R/W	°C	-20	80
2194	Delay	32 bit int.	-	R/W	sec	0	600
2196	Hysteresis	32 bit float	-	R/W	%	0	20
VOLTAGE HARMONICS ALARM							
2198	Alarm Relay	32 bit int.	SL6	R/W	-	0	2
2200	THDV High Limit	32 bit float	-	R/W	%	0	100
2202	V3 High Limit	32 bit float	-	R/W	%	0	100
2204	V5 High Limit	32 bit float	-	R/W	%	0	100
2206	V7 High Limit	32 bit float	-	R/W	%	0	100
2208	V9 High Limit	32 bit float	-	R/W	%	0	100
2210	V11 High Limit	32 bit float	-	R/W	%	0	100
2212	V13 High Limit	32 bit float	-	R/W	%	0	100
2214	V15 High Limit	32 bit float	-	R/W	%	0	100
2216	V17 High Limit	32 bit float	-	R/W	%	0	100
2218	V19 High Limit	32 bit float	-	R/W	%	0	100
2220	V21 High Limit	32 bit float	-	R/W	%	0	100
2222	Delay	32 bit int.	-	R/W	sec	0	600
CURRENT HARMONICS ALARM							
2224	Alarm Relay	32 bit int.	SL6	R/W	%	0	2
2226	THDI High Limit	32 bit float	-	R/W	%	0	100
2228	I3 High Limit	32 bit float	-	R/W	%	0	100
2230	I5 High Limit	32 bit float	-	R/W	%	0	100
2232	I7 High Limit	32 bit float	-	R/W	%	0	100
2234	I9 High Limit	32 bit float	-	R/W	%	0	100
2236	I11 High Limit	32 bit float	-	R/W	%	0	100
2238	I13 High Limit	32 bit float	-	R/W	%	0	100
2240	I15 High Limit	32 bit float	-	R/W	%	0	100
2242	I17 High Limit	32 bit float	-	R/W	%	0	100
2244	I19 High Limit	32 bit float	-	R/W	%	0	100
2246	I21 High Limit	32 bit float	-	R/W	%	0	100
2248	Delay	32 bit int.	-	R/W	sec	0	600

Address	Parameter	Data Type	Description	R/W	Unit	Low Limit	High Limit
DEVICE SETTINGS							
2250	Language	32 bit int.	SL7	R/W	-	0	1
2252	Contrast	32 bit int.	SL8	R/W	-	0	8
2254	Password	32 bit int.	-	R/W	-	0	9999
2256	Display on	32 bit int.	SL9	R/W	-	0	1
2258	Display on Time	32 bit int.	-	R/W	sec	10	600
2260	Serial Number	32 bit int.	-	RO	-	0	0
2262	Firmware Version	32 bit float	-	RO	-	0	0
2264	Order Number	32 bit int.	-	RO	-	0	0
2266	Config Name	String	-	R/W	-	0	0
2278	Device Name	String	-	R/W	-	0	0
DIGITAL OUTPUT SETTINGS (OPTIONAL*)							
2290	Output3 Mode	32 bit int.	SL3	R/W	-	0	21
2292	Output3 Energy	32 bit float	-	R/W	-	0.001	10000000000
2294	Output3 Width	32 bit int.	-	R/W	msec	50	2500
2296	Output3 Multiplier	32 bit int.	-	R/W	-	1	10000
2298	Output4 Mode	32 bit int.	SL3	R/W	-	0	21
2300	Output4 Energy	32 bit float	-	R/W	-	0.001	10000000000
2302	Output4 Width	32 bit int.	-	R/W	msec	50	2500
2304	Output4 Multiplier	32 bit int.	-	R/W	-	1	10000
2306	Output5 Mode	32 bit int.	SL3	R/W	-	0	21
2308	Output5 Energy	32 bit float	-	R/W	-	0.001	10000000000
2310	Output5 Width	32 bit int.	-	R/W	msec	50	2500
2312	Output5 Multiplier	32 bit int.	-	R/W	-	1	10000
2314	Output6 Mode	32 bit int.	SL3	R/W	-	0	21
2316	Output6 Energy	32 bit float	-	R/W	-	0.001	10000000000
2318	Output6 Width	32 bit int.	-	R/W	msec	50	2500
2320	Output6 Multiplier	32 bit int.	-	R/W	-	1	10000
2322	Output7 Mode	32 bit int.	SL3	R/W	-	0	21
2324	Output7 Energy	32 bit float	-	R/W	-	0.001	10000000000
2326	Output7 Width	32 bit int.	-	R/W	msec	50	2500
2328	Output7 Multiplier	32 bit int.	-	R/W	-	1	10000
DIGITAL INPUT SETTINGS (OPTIONAL*)							
2330	Input3 Mode	32 bit int.	SL4	R/W	-	0	2
2332	Input3 Delay	32 bit int.	-	R/W	msec	10	2000
2334	Input4 Mode	32 bit int.	SL4	R/W	-	0	2
2336	Input4 Delay	32 bit int.	-	R/W	msec	10	2000
2338	Input5 Mode	32 bit int.	SL4	R/W	-	0	2
2340	Input5 Delay	32 bit int.	-	R/W	msec	10	2000
2342	Input6 Mode	32 bit int.	SL4	R/W	-	0	2
2344	Input6 Delay	32 bit int.	-	R/W	msec	10	2000
2346	Input7 Mode	32 bit int.	SL4	R/W	-	0	2
2348	Input7 Delay	32 bit int.	-	R/W	msec	10	2000

Address	Parameter	Data Type	Description	R/W	Unit	Low Limit	High Limit
ANALOG OUTPUT SETTINGS (OPTIONAL **)							
2350	AO1 Input Mode	32 bit int.	SL10	R/W	-	1	24
2352	AO1 Output Conn.	32 bit int.	SL11	R/W	-	0	5
2354	AO1 Max. Value	32 bit float	-	R/W	-	-100000	100000
2356	AO1 Min. Value	32 bit float	-	R/W	-	-100000	100000
2358	AO1 Multiplier	32 bit int.	SL12	R/W	-	0	2
2360	AO2 Input Mode	32 bit int.	SL10	R/W	-	1	24
2362	AO2 Output Conn.	32 bit int.	SL11	R/W	-	0	5
2364	AO2 Max. Value	32 bit float	-	R/W	-	-100000	100000
2366	AO2 Min. Value	32 bit float	-	R/W	-	-100000	100000
2368	AO2 Multiplier	32 bit int.	SL12	R/W	-	0	2
2370	AO3 Input Mode	32 bit int.	SL10	R/W	-	1	24
2372	AO3 Output Conn.	32 bit int.	SL11	R/W	-	0	5
2374	AO3 Max. Value	32 bit float	-	R/W	-	-100000	100000
2376	AO3 Min. Value	32 bit float	-	R/W	-	-100000	100000
2378	AO3 Multiplier	32 bit int.	SL12	R/W	-	0	2
2380	AO4 Input Mode	32 bit int.	SL10	R/W	-	1	24
2382	AO4 Output Conn.	32 bit int.	SL11	R/W	-	0	5
2384	AO4 Max. Value	32 bit float	-	R/W	-	-100000	100000
2386	AO4 Min. Value	32 bit float	-	R/W	-	-100000	100000
2388	AO4 Multiplier	32 bit int.	SL12	R/W	-	0	2
2390	Password Activation	32 bit float	-	R/W	-	0	1
SAVE CHANGES TO PERMANENT MEMORY (Write "1")							
1998		32 bit int.		W			

* Valid for devices with optional Digital I/O.

**Valid for devices with optional Analog Output.

Table 4-6 Description List

SL1	SL2	SL3	SL4	SL5	SL6
0-3phase 4wire 1-3phase 3wire 2-Aron	0-Mega 1-Kilo	0-Off 1-T1 kWh 2-T1 kWh E. 3-T1 kVArh I 4-T1 kVArh E. 5-T1_1 kWh 6-T1_1 kWh E. 7-T1_1 kVArh I. 8-T1_1 kVArh E. 9-T1_2 kWh 10-T1_2 kWh E. 11-T1_2 kVArh I. 12-T1_2 kVArh E. 13-T1_3 kWh 14-T1_3 kWh E. 15-T1_3 kVArh I. 16-T1_3 kVArh E. 17-T2 kWh 18-T2 kWh E. 19-T2 kVArh I. 20-T2 kVArh E. 21-Digital Input	1-Off 2-2nd tariff 3-Accumulator 4-Run hour 5-DI Meter	0-2400 1-4800 2-9600 3-19200 4-38400 5-57600 6-115200	0-Off 1-Relay1 2-Relay2
SL7	SL8	SL9	SL10	SL11	SL12
0-Türkçe 1-English 2-Русский	0- Level -4 1- Level -3 2- Level -2 3- Level -1 4- Level 0 5- Level 1 6- Level 2 7- Level 3 8- Level 4	0-Continuous 1-Time Dependent	0-V1 (L-N) 1-V2 (L-N) 2-V3 (L-N) 3-I1 4-I2 5-I3 6-P1 7-P2 8-P3 9-Q1 10-Q2 11-Q3 12-S1 13-S2 14-S3 15-F 16-IN 17-V12 18-V23 19-V31 20- I tot. 21-P tot 22-Q tot. 23- S tot.	0-(0 - 5V) 1-(0 - 10V) 2-(-5 - 5V) 3-(-10 - 10V) 4-(0 - 20mA) 5-(4 - 20mA)	0-1 1-Kilo 2-Mega

EXAMPLE:

If slave ID is assigned as 157;

Request		KLEA Response	
Slave ID	01h	Slave ID	01h
Function code	10h	Function code	10h
Starting address (high)	08h	Starting address (high)	08h
Starting address (low)	26h	Starting address (low)	26h
Number of registers (high)	00h	Number of registers (high)	00h
Number of registers (low)	02h	Number of registers (low)	02h
Number of bytes	04h	CRC (high)	A2h
Register value (high)	00h	CRC (low)	63h
Register value (low)	00h		
Register value (high)	00h		
Register value (low)	9Dh		
CRC (high)	D7h		
CRC (low)	F4h		

4.5.3 ARCHIVE (HISTORY) RECORDS

Archive records consist of blocks having 68 parameters. Each parameter inside the archive block is a 32 bit length variable. Archive data block is as shown in Table 4-7.

The programmer will access archive by implementing “0x14 - Read File Record” function. “0x14 - Read File Record” function accesses the data with “file numbers”.

For Klea,

File numbers 1 – 1920 are used to access HOURLY data.

File numbers 5001- 5240 are used to access DAILY data.

File numbers 10001-10036 are used to access MONTHLY data.

- The last saved file number in the hourly data memory; can be accessed from 1360 Modbus addressed parameter (Refer to Table 4-4).
- The last saved file number in the daily data memory; can be accessed from 1362 Modbus addressed parameter (Refer to Table 4-4).
- The last saved file number in the monthly data memory; can be accessed from 1364 Modbus addressed parameter (Refer to Table 4-4).

Table 4-7 Archive (History) Record Table

Item No.	History Records	Variable Type
1	Time Info (Timestamp)	32 bit int.
2	L1 average voltage value (V ave.)	32 bit float
3	L1 minimum voltage value (V1 min.)	32 bit float
4	L1 maximum voltage value (V1 max.)	32 bit float
5	L1 average current value (I1 ave.)	32 bit float
6	L1 minimum current value (I1 min.)	32 bit float
7	L1 maximum current value (I1 max.)	32 bit float
8	L1 average active power value (P1 ave.)	32 bit float

Item No.	History Records	Variable Type
9	L1 minimum active power value (P1 min.)	32 bit float
10	L1 maximum active power value (P1 max.)	32 bit float
11	L1 average reactive power value (Q1 ave.)	32 bit float
12	L1 minimum reactive power value (Q1 min.)	32 bit float
13	L1 maximum reactive power value (Q1 max..)	32 bit float
14	L1 average apparent power value (S1 ave.)	32 bit float
15	L1 minimum apparent power value (S1 min.)	32 bit float
16	L1 maximum apparent power value (S1 max.)	32 bit float
17	L1 average cosØ value (cosØ1 ave.)	32 bit float
18	L1 average PF value (PF1 ave.)	32 bit float
19	L2 average voltage value (V2 ave.)	32 bit float
20	L2 minimum voltage value(V2 min.)	32 bit float
21	L2 maximum voltage value(V2 max.)	32 bit float
22	L2 average current value (I2 ave.)	32 bit float
23	L2 minimum current value (I2 min.)	32 bit float
24	L2 maximum current value (I2 max.)	32 bit float
25	L2 average active power value (P2 ave.)	32 bit float
26	L2 minimum active power value (P2 min.)	32 bit float
27	L2 maximum active power value (P2 max.)	32 bit float
28	L2 average reactive power value (Q2 ave.)	32 bit float
29	L2 minimum reactive power value (Q2 min.)	32 bit float
30	L2 maximum reactive power value (Q2 max..)	32 bit float
31	L2 average apparent power value (S2 ave.)	32 bit float
32	L2 minimum apparent power value (S2 min.)	32 bit float
33	L2 maximum apparent power value (S2 max.)	32 bit float
34	L2 average cosØ value (cosØ2 ave.)	32 bit float
35	L2 average PF value (PF2 ave.)	32 bit float
36	L3 average voltage value (V3 ave.)	32 bit float
37	L3 minimum voltage value (V3 min.)	32 bit float
38	L3 maximum voltage value (V3 max.)	32 bit float
39	L3 average current value (I3 ave.)	32 bit float
40	L3 minimum current value (I3 min.)	32 bit float
41	L3 maximum current value (I3 max.)	32 bit float
42	L3 average active power value (P3 ave.)	32 bit float
43	L3 minimum active power value (P3 min.)	32 bit float
44	L3 maximum active power value (P3 max.)	32 bit float
45	L3 average reactive power value (Q3 ave.)	32 bit float
46	L3 minimum reactive power value (Q3 min.)	32 bit float
47	L3 maximum reactive power value (Q3 max..)	32 bit float
48	L3 average apparent power value (S3 ave.)	32 bit float
49	L3 minimum apparent power value (S3 min.)	32 bit float
50	L3 maximum apparent power value (S3 max.)	32 bit float
51	L3 average cosØ value (cosØ3 ave.)	32 bit float
52	L3 average PF value (PF3 ave.)	32 bit float

Item No.	History Records	Variable Type
53	V12 voltage average value (V12 ave.)	32 bit float
54	V12 voltage minimum value (V12 min.)	32 bit float
55	V12 voltage maximum value (V12 max.)	32 bit float
56	V23 voltage average value (V23 ave.)	32 bit float
57	V23 voltage minimum value (V23 min.)	32 bit float
58	V23 voltage maximum value (V23 max.)	32 bit float
59	V31 voltage average value (V31 ave.)	32 bit float
60	V31 voltage minimum value (V31 min.)	32 bit float
61	V31 voltage maximum value (V31 max.)	32 bit float
62	L1 average frequency value (F1 ave.)	32 bit float
63	L1 minimum frequency value (F1 min.)	32 bit float
64	L1 maximum frequency value (F1 max.)	32 bit float
65	T1 meters consumed-imp. active energy value (T1 kWh)	32 bit float
66	T1 meters generated-exp. active energy value (T1 kWh E.)	32 bit float
67	T1 meters consumed-imp. reactive energy value (T1 kVArh I.)	32 bit float
68	T1 meters generated-exp. reactive energy value (T1 kVArh E.)	32 bit float

4.5.3.1 Hourly archive data

The smallest and largest instantaneous values measured during one hour period, are saved as minimum and maximum values. Likewise, average values of measurements, which were taken in one hour period, are saved as average values.

14h function operates with file numbers. File numbers between 1 – 1920 are used for HOURLY data.

Klea has a memory that is reserved for hourly files. It can keep totally 1920 hourly files. Assume that, reserved memory for hourly files are filled completely. In this case, the last saved file number will be “1920” and user can access this number with querying 1360th modbus address (refer to table 4-4).

Example for upper case;

1st file memory=> Hourly Data Record-1
2nd file memory=> Hourly Data Record-2
3rd file memory=> Hourly Data Record-3
.
.
.
19th file memory=> Hourly Data Record-1919
20th file memory=> Hourly Data Record-1920

If there is no enough memory for one more hourly data, the oldest record is deleted and the latest record is saved to first file memory. In this case, the last saved file number will be “1”. User can access this number with querying 1360th modbus address (refer to table 4-4).

Example for upper case;

1st file memory=> Hourly Data Record-1921
2nd file memory=> Hourly Data Record-1920
3rd file memory=> Hourly Data Record-3
.
.
.
19th file memory=> Hourly Data Record-1919
20th file memory=> Hourly Data Record-1920

When one more hourly record is come, the last saved file number will be "2".

Example of upper case;

1st file memory=> Hourly Data Record-1921
2nd file memory=> Hourly Data Record-1922
3rd file memory=> Hourly Data Record-3
.
.
.
19th file memory=> Hourly Data Record-1919
20th file memory=> Hourly Data Record-1920

Briefly, when Klea's hourly memory is filled completely, oldest record is deleted and new record is saved in the deleted record's memory.

The 'last saved file number' inside the hourly memory can be accessed from the 32-bit parameter starting from Modbus address 1360 (Refer to Table 4-4).

EXAMPLE:

Assume that a programmer will try to access a Klea with a slave ID number 1. Assume also that the last saved hourly file number of this device is 17. In this case, data request and Klea response will be as follows:

Sorgu	
Slave ID	0x01
Function code	0x14
Byte Counts	0x07
Sub-req. 1 reference type	0x06
Sub-req. 1 file number HI	0x00
Sub-req. 1 file number LO	0x11
Sub-req. 1 starting reg. addr. HI	0x00
Sub-req. 1 starting reg. addr. LO	0x00
Sub-req. 1 register count HI	0x00
Sub-req. 1 register count LO	0x0A
CRC HI	0xB3
CRC LO	0xD4

Klea cevap	
Slave ID	0x01
Function code	0x14
Byte count	0x16
Sub-req. 1 byte count	0x15
Sub-req. 1 reference type	0x06
Timestamp	XXX
Timestamp	XXX
Timestamp	XXX
Timestamp	XXX

CRC HI	XXX
CRC LO	XXX

The parameters and CRC values in above tables, are as they should be. On the other hand, Klea response is given to describe the message structure. As a result, values for variables are not defined.

4.5.3.2 Daily archive data

Recording of daily data changes with start of day ([Refer to 3.2.1.1.3.4](#)) setting.

The smallest and largest instantaneous values measured during one day period, are saved as minimum and maximum values. Likewise, average values of measurements, which were taken in one day period, are saved as average values.

14h function operates with file numbers. File numbers 5001 – 5240 are used for DAILY data.

Klea has a memory that is reserved for daily files. It can keep totally 240 daily files. When Klea's daily memory is filled completely, oldest record is deleted and new record is saved in the deleted record's memory. For more information about record structure of Klea, please look at [4.5.3.1 Hourly archive data](#).

The 'last saved file number' inside the daily memory can be accessed from the 32-bit parameter starting from Modbus address 1362 ([Refer to Table 4-4](#)).

4.5.3.3 Monthly archive data

Recording of daily data changes with start of month ([Refer to 3.2.1.1.3.5](#)) and start of day ([Refer to 3.2.1.1.3.4](#)) settings.

The smallest and largest instantaneous values measured during one month period, are saved as minimum and maximum values. Likewise, average values of measurements, which were taken in one month period, are saved as average values.

14h function operates with file numbers. File numbers 10001 – 10036 are used for MONTHLY data.

Klea has a memory that is reserved for monthly files. It can keep totally 36 monthly files. When Klea's monthly memory is filled completely, oldest record is deleted and new record is saved in the deleted record's memory. For more information about record structure of Klea, please look at [4.5.3.1 Hourly archive data](#).

The 'last saved file number' inside the monthly memory can be accessed from the 32-bit parameter starting from Modbus address 1364 ([Refer to Table 4-4](#)).

4.5.4 Clear

Operator/programmer can erase/zeroize data stored in non-volatile memory via MODBUS commands. Erasable data are as follows:

- energy meters (all Tariff 1 and Tariff 2 meters)
- demand values
- all digital input counters
- all variables mentioned above
- hourly archive records
- daily archive records
- monthly archive records
- alarm records

Table 4-8 Clear Address Table

Address	Data Type	Parameters/Records to be Cleared	R/W	Value	Modbus func.
1900	32 bit int.	Energy meters	W	1	10H-06H
1902	32 bit int.	Demand values	W	1	10H-06H
1904	32 bit int.	Digital input counters	W	1	10H-06H
1906	32 bit int.	All variables above	W	1	10H-06H
1908	32 bit int.	Run Hour	W	1	10H-06H
1910	32 bit int.	Hourly archive records	W	1	10H-06H
1912	32 bit int.	Daily archive records	W	1	10H-06H
1914	32 bit int.	Monthly archive records	W	1	10H-06H
1916	32 bit int.	Alarm records	W	1	10H-06H
In order to complete to erase/zeroize, programmer should write 1 to the below MODBUS address:					
1898	32 bit int.	Complete erasing/zeroizing	W	1	10H-06H



In order to complete clearing process, operator/programmer should:

- Write "1" to registers related with 'to be cleared parameters'
- Then, write 0 to 1898 register, and 1 to 1899 register, "within 60 seconds".

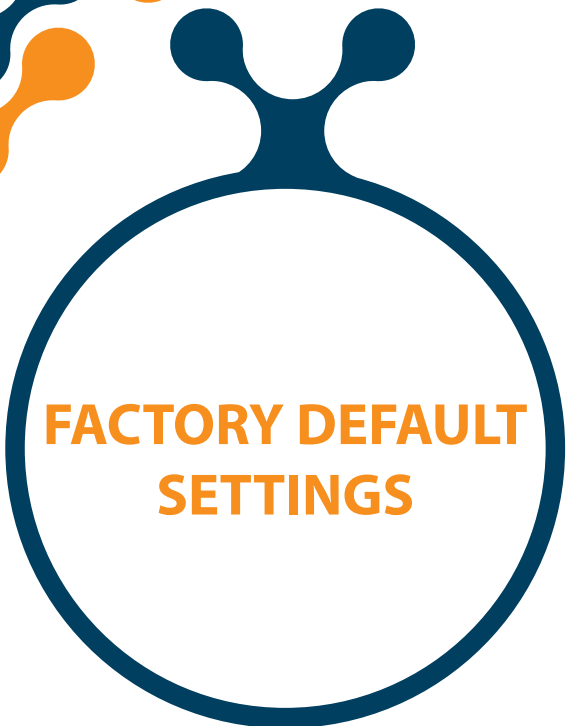

FACTORY DEFAULT SETTINGS

	Default value	Unit	Setting Range
Network Settings			
Current Transf. Ratio (CTR)	1	-	1↔5000
Voltage Transf. Ratio (VTR)	1.0	-	1↔5000
Connection	3 phase 4 wire	-	3phase 4wire/3 phase 3wire/Aron
Demand Period	15	min.	1↔60
Power Unit	Kilo	-	Kilo/Mega
Device Settings			
Language	English	-	Türkçe/English/ Русский
Contrast	Level 0	-	Level 4↔Level -4
New Password	1	-	1↔9999
Display on	Time dependent	-	Time dependent/Continuous
Display on time	600	sec.	10↔600
Energy Settings			
T1_1 Start Time	8	-	0↔23
T1_2 Start Time	16	-	0↔23
T1_3 Start Time	0	-	0↔23
Start of day	0	-	0↔23
Start of month	1	-	1↔28
T1 kWh	0.0	kWh	0.0↔20000000000.0
T1 kWh E.	0.0	kWh	0.0↔20000000000.0
T1 kVArh I.	0.0	kVArh	0.0↔20000000000.0
T1 kVArh E.	0.0	kVArh	0.0↔20000000000.0
T1_1 kWh	0.0	kWh	0.0↔20000000000.0
T1_1 kWh E.	0.0	kWh	0.0↔20000000000.0
T1_1 kVArh I.	0.0	kVArh	0.0↔20000000000.0
T1_1 kVArh E.	0.0	kVArh	0.0↔20000000000.0
T1_2 kWh	0.0	kWh	0.0↔20000000000.0
T1_2 kWh E.	0.0	kWh	0.0↔20000000000.0
T1_2 kVArh I.	0.0	kVArh	0.0↔20000000000.0
T1_2 kVArh E.	0.0	kVArh	0.0↔20000000000.0
T1_3 kWh	0.0	kWh	0.0↔20000000000.0
T1_3 kWh E.	0.0	kWh	0.0↔20000000000.0
T1_3 kVArh I.	0.0	kVArh	0.0↔20000000000.0
T1_3 kVArh E.	0.0	kVArh	0.0↔20000000000.0
T2 kWh	0.0	kWh	0.0↔20000000000.0
T2 kWh E.	0.0	kWh	0.0↔20000000000.0
T2 kVArh I.	0.0	kVArh	0.0↔20000000000.0
T2 kVArh E.	0.0	kVArh	0.0↔20000000000.0
Digital Input Settings			
Mode (Input1, 2 -- 7)	Off	-	Off/2nd Tariff/Counter
Delay (Input1, 2 -- 7)	100	msec	10↔2000

	Default value	Unit	Setting Range
Digital Output Settings			
Mode (Output1, 2 -- 7)	Off	-	Refer to 3.2.1.1.5 Digital Output
Energy (Output1, 2 -- 7)	1	kWh/kVArh	0.001↔10000000000
Width (Output1, 2 -- 7)	100	msec	50↔2500
Multiplier (Output1, 2 -- 7)	1	-	1↔10000
Analog Output Settings			
Input mode	Refer to 3.2.1.1.6	-	Refer to 3.2.1.1.6
Output conn.	0 – 5V	V/mA	Refer to 3.2.1.1.6
Min. value	0.0	-	Refer to 3.2.1.1.6
Max. value	0.0	-	Refer to 3.2.1.1.6
Multiplier	1	-	1/Kilo/Mega
Communications Settings			
Baud Rate	38400	Bits/sec.	2400/4800/9600/19200/38400/57600/115200
Slave Id	1	-	1↔247
Alarm Settings			
V(L-N)			
Low Limit	0.0	V	0.0↔1500000.0
High Limit	0.0	V	0.0↔1500000.0
V(L-L)			
Low Limit	0.0	V	0.0↔2600000.0
High Limit	0.0	V	0.0↔2600000.0
CURRENT			
Low Limit	0.0	A	0.0↔30000.0
High Limit	0.0	A	0.0↔30000.0
P			
Low Limit	0.0	W	-10000000000.0↔10000000000.0
High Limit	0.0	W	-10000000000.0↔10000000000.0
Q			
Low Limit	0.0	VAr	-10000000000.0↔10000000000.0
High Limit	0.0	VAr	-10000000000.0↔10000000000.0
S			
Low Limit	0.0	VA	0.0↔10000000000.0
High Limit	0.0	VA	0.0↔10000000000.0
CosØ			
Low Limit	0.0	-	0.000↔1.000
High Limit	0.0	-	0.000↔1.000
PF			
Low Limit	0.0	-	0.000↔1.000
High Limit	0.0	-	0.000↔1.000
IN			
Low Limit	0.0	A	0.0↔90000.0
High Limit	0.0	A	0.0↔90000.0
F			
Low Limit	0.0	Hz	35↔70

	Default value	Unit	Setting Range
High Limit	0.0	Hz	35↔70
Temp.			
Low Limit	0.0	°C	-20↔80
High Limit	0.0	°C	-20↔80
V Harmonics			
THDV High limit	0.0	%	0.0↔100.0
V3 --- V21	0.0	%	0.0↔100.0
I Harmonics			
THDI High limit	0.0	%	0.0↔100.0
I3 --- I21	0.0	%	0.0↔100.0
Alarm Relay and Alarm Time of V(L-N), V(L-L), Current, P, Q, S, CosØ, PF, IN, F, V Harmonics, I Harmonics and Temp. alarms			
Alarm Relay	Off	-	Off/Relay1/Relay2
Alarm Time	0	sec.	0↔600
Alarm Time (for V, I Harmonics)	60	sec	0↔600
Hysteresis of V(L-N), V(L-L), Current, P, Q, S, CosØ, PF, IN, F, V Harmonics, I Harmonics and Temp. alarms			
Hysteresis	0.0	%	0.0↔20.0



TECHNICAL SPECIFICATIONS

Supply

Voltage	85..300V AC/DC
Frequency	45..65 Hz

Measurement Inputs

Voltage	1..300 V RMS (L-N)
Current	0.05..6 A RMS
Frequency	45..65 Hz

Measurement Accuracy

Function Symbol	Function	Function Performance Class According to IEC 61557-12	Measuring Range	Other Complementary Characteristics
P	Total active power	0,2	1 % $I_n \leq I \leq I_{max}$ 0,5 Ind to 0,8 Cap	-
Q_V	Total reactive power	1	2 % $I_n \leq I \leq I_{max}$ 0,25 Ind to 0,25 Cap	-
S_A	Total apparent power	0,2	2 % $I_n \leq I \leq I_{max}$	-
E_A	Total active energy	0,2	0 to 49999999999	IEC 62053-22 Class 0.2S
E_{rV}	Total reactive energy	2	0 to 49999999999	IEC 62053-23 Class 2
f	Frequency	0,05	45 – 65 Hz	-
I	Phase current	0,2	10 % $I_n \leq I \leq I_{max}$	-
I_{Nc}	Neutral current (calculated)	0,5	10 % $I_n \leq I \leq I_{max}$	-
U	Voltage	0,2	$U_{min} \leq U \leq U_{max}$	-
PF_A	Power factor	0,5	0,5 Ind to 0,8 Cap	-
THDV	Total harmonic distortion voltage	1	0 % to 20 %	-
THDI	Total harmonic distortion current	1	0 % to 100 %	-

Relay Outputs

2 pcs,	
Max. switching current	: 5A
Max. switching voltage	: 250 VAC
Max. switching power	: 1250 VA

Digital Input/Output (Digital IO)

2 pcs, 5...30V DC, 50mA
Protection: 3750VRMS , Insulation

Analog Output

2 pcs. (2 pcs. analog output optional model) / 4 pcs. (4 pcs. analog output optional model)
0-5V, 0-10V, -5-5V, -10-10V, 0-20mA, 4-20mA

Current Transformer Ratio (CTR)

1..5000 adjustable.

Voltage Transformer Ratio (VTR)

1..5000 adjustable.

Connection Type

3phase 4 wire
3phase 3 wire
Aron

Demand Period

1-60 minutes adjustable.

Operating Temperature

-20°C..+70°C

Storage Temperature

-30°C..+80°C

Relative Humidity

Max. 95%, no condensation

Sizes

W96 x H96 x D72

Protection Class

IP40 front
IP20 back

Power Consumption

<3VA

